



Dell PowerEdge T320 Systems Owner's Manual

Regulatory Model: E20S Series
Regulatory Type: E20S001



Notes, Cautions, and Warnings

-  **NOTE:** A NOTE indicates important information that helps you make better use of your computer.
-  **CAUTION:** A CAUTION indicates either potential damage to hardware or loss of data and tells you how to avoid the problem.
-  **WARNING:** A WARNING indicates a potential for property damage, personal injury, or death.

© 2013 Dell Inc. All Rights Reserved.

Trademarks used in this text: Dell™, the Dell logo, Dell Boomi™, Dell Precision™, OptiPlex™, Latitude™, PowerEdge™, PowerVault™, PowerConnect™, OpenManage™, EqualLogic™, Compellent™, KACE™, FlexAddress™, Force10™, Venue™ and Vostro™ are trademarks of Dell Inc. Intel®, Pentium®, Xeon®, Core® and Celeron® are registered trademarks of Intel Corporation in the U.S. and other countries. AMD® is a registered trademark and AMD Opteron™, AMD Phenom™ and AMD Sempron™ are trademarks of Advanced Micro Devices, Inc. Microsoft®, Windows®, Windows Server®, Internet Explorer®, MS-DOS®, Windows Vista® and Active Directory® are either trademarks or registered trademarks of Microsoft Corporation in the United States and/or other countries. Red Hat® and Red Hat® Enterprise Linux® are registered trademarks of Red Hat, Inc. in the United States and/or other countries. Novell® and SUSE® are registered trademarks of Novell Inc. in the United States and other countries. Oracle® is a registered trademark of Oracle Corporation and/or its affiliates. Citrix®, Xen®, XenServer® and XenMotion® are either registered trademarks or trademarks of Citrix Systems, Inc. in the United States and/or other countries. VMware®, vMotion®, vCenter®, vCenter SRM™ and vSphere® are registered trademarks or trademarks of VMware, Inc. in the United States or other countries. IBM® is a registered trademark of International Business Machines Corporation.

2013 - 11

Rev. A04

Contents

1 About Your System.....	9
Front-Panel Features And Indicators—Tower Mode.....	9
Front-Panel Features And Indicators—Rack Mode.....	14
LCD Panel Features.....	15
Home Screen.....	16
Setup Menu.....	16
View Menu.....	17
Diagnostic Indicators.....	17
Hard-Drive Indicator Patterns.....	19
Back-Panel Features And Indicators.....	20
NIC Indicator Codes.....	22
Power Indicator Codes For Redundant Power Supply.....	22
Power Indicator Codes For Non-Redundant Power Supply.....	23
Other Information You May Need.....	24
2 Using The System Setup And Boot Manager.....	25
Choosing The System Boot Mode.....	25
Entering System Setup.....	26
Responding To Error Messages.....	26
Using The System Setup Navigation Keys.....	26
System Setup Options.....	27
System Setup Main Screen.....	27
System BIOS Screen.....	27
System Information Screen.....	27
Memory Settings Screen.....	28
Processor Settings Screen.....	28
SATA Settings Screen.....	30
Boot Settings Screen.....	30
Integrated Devices Screen.....	31
Serial Communications Screen.....	31
System Profile Settings Screen.....	32
System Security Screen.....	33
Miscellaneous Settings.....	34
System And Setup Password Features.....	34
Assigning A System And/Or Setup Password.....	35
Deleting Or Changing An Existing System And/Or Setup Password.....	35
Using Your System Password To Secure Your System.....	36
Operating With A Setup Password Enabled.....	36

Entering The UEFI Boot Manager.....	36
Using The Boot Manager Navigation Keys.....	37
Boot Manager Screen.....	37
UEFI Boot Menu.....	38
Embedded System Management.....	38
iDRAC Settings Utility.....	38
Entering The iDRAC Settings Utility.....	38
Changing The Thermal Settings.....	38

3 Installing System Components.....41

Recommended Tools.....	41
Front Bezel (Optional).....	41
Installing The Front Bezel.....	41
Removing The Front Bezel.....	42
System Feet—Tower Mode.....	42
Removing The System Feet.....	43
Installing The System Feet.....	43
Wheel Assembly (Optional)—Tower Mode.....	43
Removing The Wheel Assembly.....	44
Installing The Wheel Assembly.....	45
Opening And Closing The System.....	45
Opening The System.....	45
Closing The System.....	46
Inside The System.....	46
Optical Drives And Tape Drives (Optional).....	48
Removing The Optical Drive Or Tape Drive.....	49
Installing The Optical Drive Or Tape Drive.....	52
Cooling Shroud.....	52
Removing The Cooling Shroud.....	52
Installing The Cooling Shroud.....	53
Hard Drives—Hot-Swappable	54
Removing A Hot-Swap Hard Drive.....	54
Installing A Hot-Swap Hard Drive.....	55
Removing A 2.5 Inch Hard-Drive Blank.....	56
Installing A 2.5 Inch Hard-Drive Blank.....	56
Removing A 3.5 Inch Hard-Drive Blank.....	56
Installing A 3.5 Inch Hard-Drive Blank.....	57
Removing A 2.5 Inch Hard Drive From A 3.5 Inch Hard-Drive Adapter.....	57
Installing A 2.5 Inch Hard Drive Into A 3.5 Inch Hard-Drive Adapter.....	58
Removing A Hard Drive Or A Hard-Drive Adapter From A Hard-Drive Carrier.....	58
Installing A Hard Drive Or A Hard-Drive Adapter Into A Hard-Drive Carrier.....	59
Hard Drives—Cabled.....	59

Removing The Internal Hard-Drive Bay.....	60
Installing The Internal Hard-Drive Bay.....	61
Removing A Cabled Hard Drive.....	61
Installing A Cabled Hard Drive.....	62
Hard-Drive Backplane.....	63
Removing The Hard-Drive Backplane.....	63
Installing The Hard-Drive Backplane.....	69
Four-Slot Hard-Drive Blank.....	70
Removing A Four-Slot Hard-Drive Blank.....	70
Installing A Four-Slot Hard-Drive Blank.....	71
System Memory.....	71
General Memory Module Installation Guidelines.....	73
Mode-Specific Guidelines.....	73
Sample Memory Configurations.....	74
Removing Memory Modules.....	75
Installing Memory Modules.....	76
Cooling Fans.....	78
Removing The Internal Cooling Fan.....	78
Installing The Internal Cooling Fan.....	80
Removing The External Cooling Fan	80
Installing The External Cooling Fan.....	82
Internal USB Memory Key (Optional).....	82
Replacing The Internal USB Key.....	83
PCIe Card Holder (Optional).....	84
Removing The PCIe Card Holder.....	84
Installing The PCIe Card Holder.....	85
Expansion Cards.....	85
Expansion Card Installation Guidelines.....	85
GPU Card Installation Guidelines.....	86
Removing An Expansion Card.....	86
Installing An Expansion Card.....	87
Removing A GPU Card.....	88
Installing A GPU Card.....	89
iDRAC Ports Card.....	90
Removing The iDRAC Ports Card.....	90
Installing The iDRAC Ports Card.....	91
Replacing An SD vFlash Card.....	92
Internal Dual SD Module.....	92
Removing An Internal Dual SD Module.....	92
Installing An Internal Dual SD Module.....	93
Internal SD Card.....	94
Removing An Internal SD Card.....	94

Installing An Internal SD Card.....	94
Processors.....	95
Removing A Processor.....	95
Installing A Processor.....	97
Redundant AC Power Supply.....	98
Removing A Redundant AC Power Supply.....	98
Installing A Redundant AC Power Supply.....	99
Removing The Power Supply Blank.....	100
Installing The Power Supply Blank.....	100
Replacing The Power Supply Divider.....	101
Non-Redundant AC Power Supply	102
Removing A Non-Redundant AC Power Supply.....	102
Installing A Non-Redundant AC Power Supply.....	104
Power Distribution Board And Power Interposer Board.....	104
Removing The Power Interposer Board.....	104
Installing The Power Interposer Board.....	106
Replacing The Power Distribution Board.....	106
System Battery.....	106
Replacing The System Battery.....	106
Control-Panel Assembly.....	107
Removing The Control-Panel Assembly.....	108
Installing The Control-Panel Assembly.....	111
Removing The Control Panel.....	111
Installing The Control Panel.....	113
Removing The Control-Panel Board For Systems With LCD Modules.....	113
Installing The Control-Panel Board For Systems With LCD Modules.....	114
Removing The Control-Panel Board For Systems With Diagnostic Indicators.....	115
Installing The Control-Panel Board For Systems With Diagnostic Indicators.....	116
Removing The LCD Module.....	116
Installing The LCD Module.....	117
Removing The VGA Module—Rack Mode.....	118
Installing The VGA Module—Rack Mode.....	119
System Board.....	119
Removing The System Board.....	119
Installing The System Board.....	120

4 Converting The System From Tower Mode To Rack Mode..... 123

Safety Instructions.....	123
Preparing A System For Conversion From Tower Mode To Rack Mode.....	123
Rack Installation.....	125

5 Troubleshooting Your System..... 127

Safety First—For You And Your System.....	127
Troubleshooting System Startup Failure.....	127
Troubleshooting External Connections.....	127
Troubleshooting The Video Subsystem.....	127
Troubleshooting A USB Device.....	127
Troubleshooting A Serial I/O Device.....	128
Troubleshooting A NIC.....	128
Troubleshooting A Wet System.....	129
Troubleshooting A Damaged System.....	129
Troubleshooting The System Battery.....	130
Troubleshooting A Non-Redundant Power Supply.....	130
Troubleshooting Redundant Power Supplies.....	131
Troubleshooting Cooling Problems.....	131
Troubleshooting Cooling Fans.....	131
Troubleshooting System Memory.....	131
Troubleshooting An Internal USB Key.....	132
Troubleshooting An SD Card.....	133
Troubleshooting An Optical Or Tape Drive.....	133
Troubleshooting A Hard Drive.....	134
Troubleshooting Expansion Cards.....	134
Troubleshooting Processor.....	135
6 Using System Diagnostics.....	137
Dell Online Diagnostics.....	137
Dell Embedded System Diagnostics.....	137
When To Use The Embedded System Diagnostics.....	137
Running The Embedded System Diagnostics.....	137
System Diagnostic Controls.....	138
7 Jumpers And Connectors.....	139
System Board Jumper Settings.....	139
System Board Connectors.....	140
Disabling A Forgotten Password.....	141
8 Technical Specifications.....	143
9 System Messages.....	149
LCD Messages.....	149
Viewing LCD Messages.....	149
Removing LCD Messages.....	149
System Error Messages.....	149
Warning Messages.....	165

Diagnostic Messages.....	165
Alert Messages.....	165
10 Getting Help.....	167
Contacting Dell.....	167

About Your System

Front-Panel Features And Indicators—Tower Mode

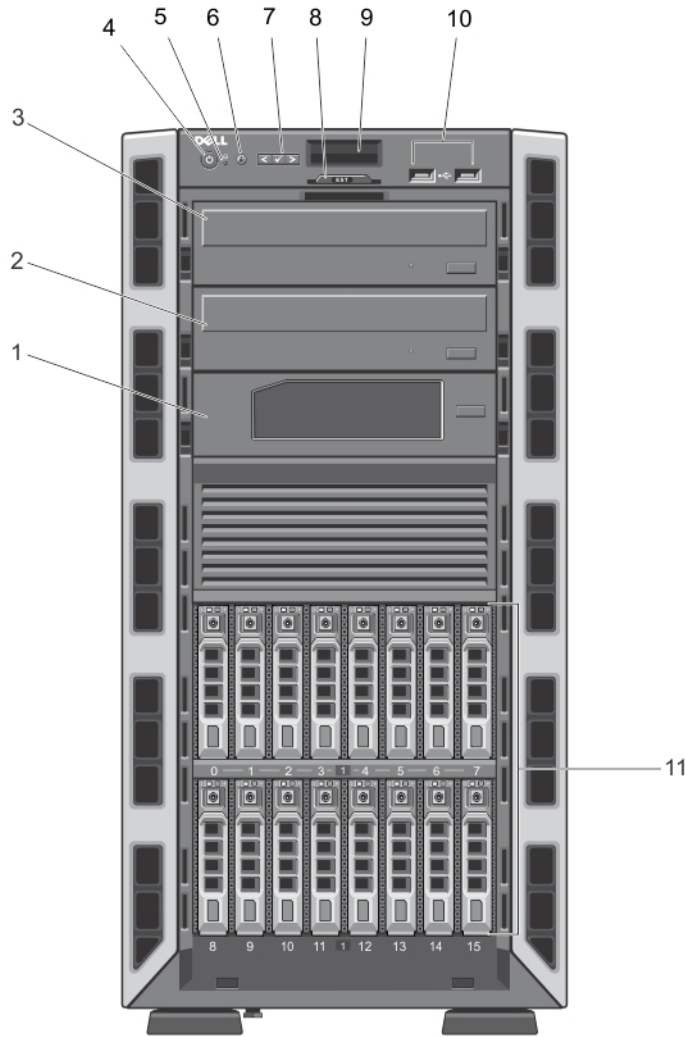

Figure 1. Front-Panel Features and Indicators—2.5 Inch Hot-Swappable Hard-Drive Chassis

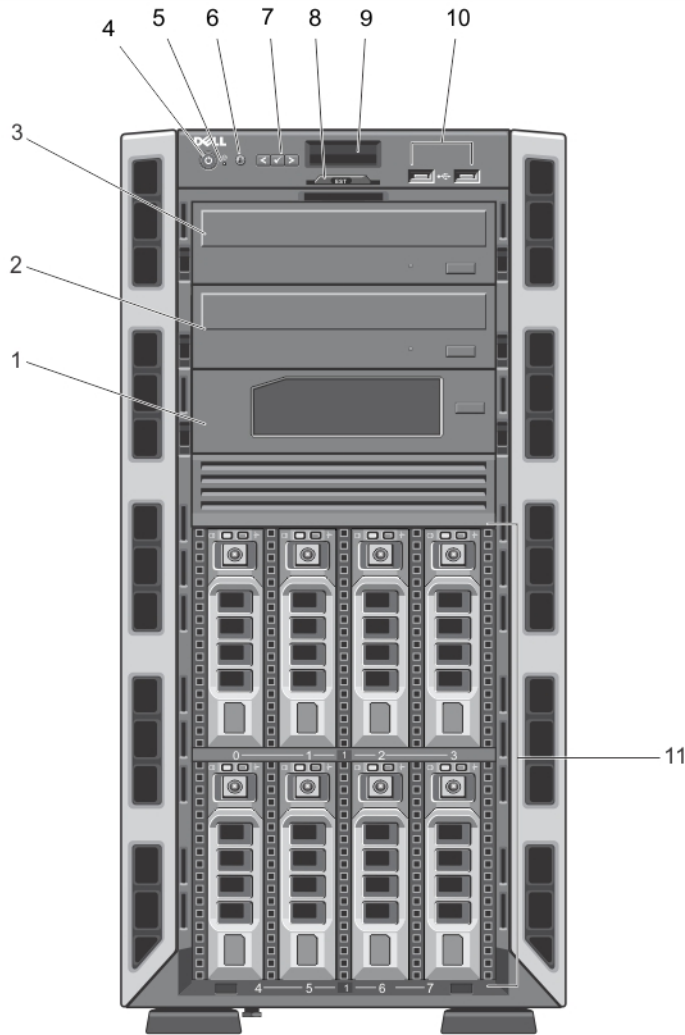









Figure 2. Front-Panel Features and Indicators—3.5 Inch Hot-Swappable Hard-Drive Chassis

Item	Indicator, Button, or Connector	Icon	Description
1	Tape drive (optional)		One optional 5.25 inch tape drive.  NOTE: If your system is installed with a double-width GPU card, the system supports only one 5.25 inch removable media storage device.
2	Optical drive 2 (optional)		Up to two optional SATA DVD-ROM drive or DVD+/-RW drive.
3	Optical drive 1 (optional)		 NOTE: If your system is installed with a double-width GPU card, the system supports only one 5.25 inch removable media storage device.

Item	Indicator, Button, or Connector	Icon	Description
4	Power-on indicator, power button		<p>The power-on indicator lights when the system power is on. The power button controls the power supply output to the system.</p> <p> NOTE: On Advanced Configuration and Power Interface (ACPI)-compliant operating systems, turning off the system using the power button causes the system to perform a graceful shutdown before power to the system is turned off.</p>
5	NMI button		<p>Used to troubleshoot software and device driver errors when running certain operating systems. This button can be pressed using the end of a paper clip.</p> <p>Use this button only if directed to do so by qualified support personnel or by the operating system documentation.</p>
6	System identification button		<p>The identification buttons on the front and back panels of the system can be used to locate a particular system within a rack. When one of these buttons is pressed, the LCD panel on the front and the system status indicator on the back flash until one of the buttons is pressed again. Press to toggle the system ID on and off.</p> <p>If the system stops responding during POST, press and hold the system ID button for more than five seconds to enter BIOS progress mode.</p> <p>To reset integrated Dell Remote Access Controller (iDRAC) (if not disabled in F2 iDRAC setup), press and hold for more than 15 seconds.</p>
7	LCD menu buttons		Allow you to navigate the control panel LCD menu.
8	Information tag		A slide-out label panel which allows you to record system information such as Service Tag, NIC, MAC address, and so on.
9	LCD panel		<p>Displays system ID, status information, and system error messages. The LCD lights blue during normal system operation. The LCD lights amber when the system needs attention, and displays an error code followed by descriptive text.</p> <p> NOTE: If the system is connected to a power source and an error is detected, the LCD lights amber regardless of whether the system is turned on or off.</p>
10	USB connectors (2)		Allow you to connect USB devices to the system. The ports are USB 2.0-compliant.
11	Hard drives		<p>Your system supports one of the following configurations:</p> <ul style="list-style-type: none"> • Up to eight 3.5 inch hot-swappable hard drives • Up to eight 2.5 inch hot-swappable hard drives installed in the 3.5 inch hard-drive carriers

Item	Indicator, Button, or Connector	Icon	Description
------	---------------------------------	------	-------------

- Up to sixteen 2.5 inch hot-swappable hard drives

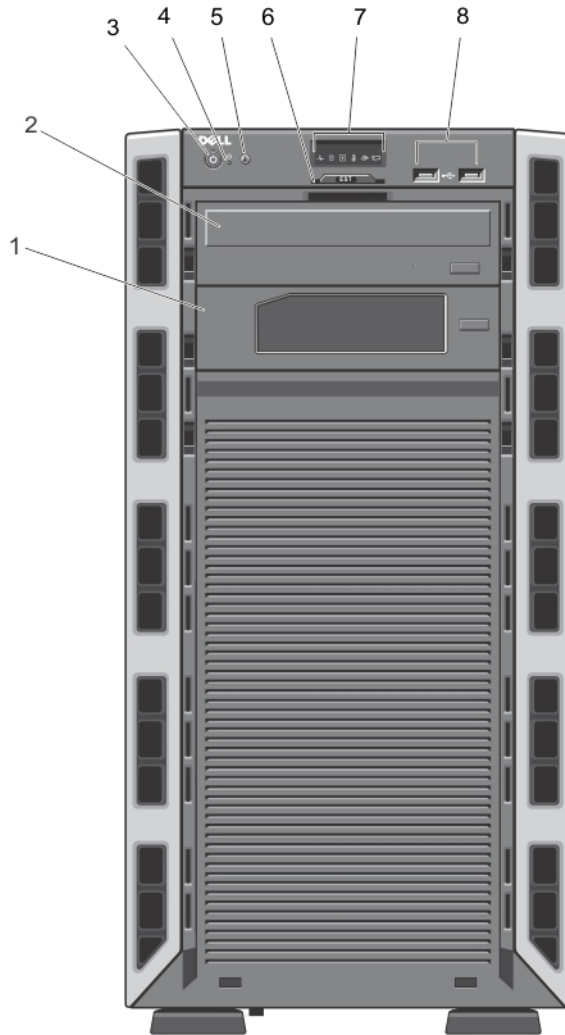







Figure 3. Front-Panel Features and Indicators—3.5 Inch Cabled Hard-Drive Chassis

NOTE: Cabled hard-drive systems are not rackable.

Item	Indicator, Button, or Connector	Icon	Description
1	Tape drive (optional)		One optional 5.25 inch tape drive.
2	Optical drive (optional)		One optional SATA DVD-ROM drive or DVD+/-RW drive.

Item	Indicator, Button, or Connector	Icon	Description
3	Power-on indicator, power button		<p>The power-on indicator lights when the system power is on. The power button controls the power supply output to the system.</p> <p> NOTE: On ACPI-compliant operating systems, turning off the system using the power button causes the system to perform a graceful shutdown before power to the system is turned off.</p>
4	NMI button		<p>Used to troubleshoot software and device driver errors when running certain operating systems. This button can be pressed using the end of a paper clip.</p> <p>Use this button only if directed to do so by qualified support personnel or by the operating system documentation.</p>
5	System identification button		<p>The identification buttons on the front and back panels of the system can be used to locate a particular system within a rack. When one of these buttons is pressed, the LCD panel on the front chassis and the system status indicator on the back chassis flash until one of the buttons is pressed again.</p> <p>Press to toggle the system ID on and off.</p> <p>If the system stops responding during POST, press and hold the system ID button for more than five seconds to enter BIOS progress mode.</p> <p>To reset iDRAC (if not disabled in F2 iDRAC setup), press and hold for more than 15 seconds.</p>
6	Information tag		A slide-out label panel which allows you to record system information such as Service Tag, NIC, MAC address, and so on.
7	Diagnostic indicators		The diagnostic indicators light up to display error status.
8	USB connectors (2)		Allow you to connect USB devices to the system. The ports are USB 2.0-compliant.

Front-Panel Features And Indicators—Rack Mode

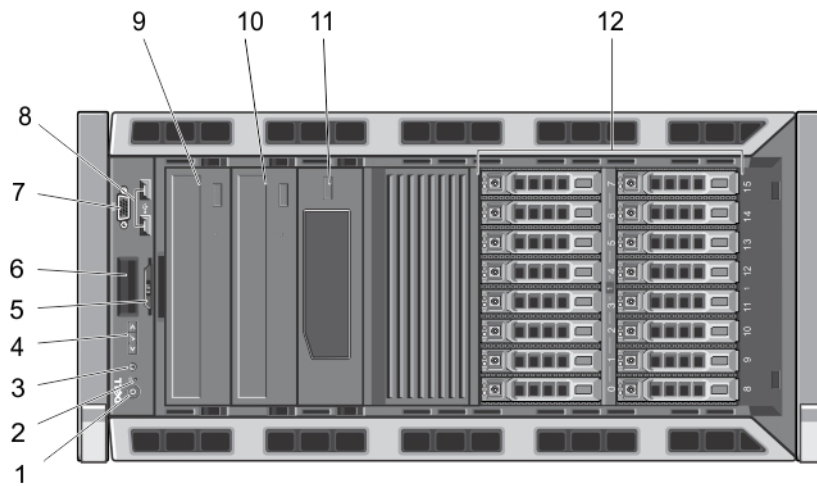







Figure 4. Front-Panel Features and Indicators

NOTE: Only systems with hot-swappable hard drives are rackable.

Item	Indicator, Button, or Connector	Icon	Description
1	Power-on indicator, power button		<p>The power-on indicator lights when the system power is on. The power button controls the power supply output to the system.</p> <p>NOTE: On ACPI-compliant operating systems, turning off the system using the power button causes the system to perform a graceful shutdown before power to the system is turned off.</p>
2	NMI button		<p>Used to troubleshoot software and device driver errors when running certain operating systems. This button can be pressed using the end of a paper clip.</p> <p>Use this button only if directed to do so by qualified support personnel or by the operating system documentation.</p>
3	System identification button		<p>The identification buttons on the front and back panels can be used to locate a particular system within a rack. When one of these buttons is pressed, the LCD panel on the front and the system status indicator on the back flash until one of the buttons is pressed again.</p> <p>Press to toggle the system ID on and off.</p> <p>If the system stops responding during POST, press and hold the system ID button for more than five seconds to enter BIOS progress mode.</p> <p>To reset iDRAC (if not disabled in F2 iDRAC setup) press and hold for more than 15 seconds.</p>

Item	Indicator, Button, or Connector	Icon	Description
4	LCD menu buttons		Allow you to navigate the control panel LCD menu.
5	Information tag		A slide-out label panel which allows you to record system information such as Service Tag, NIC, MAC address, and so on.
6	LCD panel		Displays system ID, status information, and system error messages. The LCD lights blue during normal system operation. The LCD lights amber when the system needs attention, and the LCD panel displays an error code followed by descriptive text.  NOTE: If the system is connected to a power source and an error is detected, the LCD lights amber regardless of whether the system is turned on or off.
7	Video connector		Allows you to connect a VGA display to the system.
8	USB connectors (2)		Allow you to connect USB devices to the system. The ports are USB 2.0-compliant.
9	Optical drive 1 (optional)		Up to two optional SATA DVD-ROM drive or DVD+/-RW drive.  NOTE: If your system is installed with a double-width GPU card, the system supports only one 5.25 inch removable media storage device.
10	Optical drive 2 (optional)		
11	Tape drive (optional)		One 5.25 inch optional tape drive.  NOTE: If your system is installed with a double-width GPU card, the system supports only one 5.25 inch removable media storage device.
12	Hard drives		Your system supports one of the following configurations: <ul style="list-style-type: none"> • Up to eight 3.5 inch hot-swappable hard drives. • Up to eight 2.5 inch hot-swappable hard drives installed in 3.5 inch hard-drive carriers. • Up to sixteen 2.5 inch hot-swappable hard drives.

LCD Panel Features

 **NOTE:** The LCD panel is supported only on systems with hot-swappable hard drives.

The system's LCD panel provides system information and status and error messages to indicate when the system is operating correctly or when the system needs attention. See System Error Messages for information about specific error codes.

- The LCD backlight lights blue during normal operating conditions and lights amber to indicate an error condition.
- The LCD backlight is off when the system is in standby mode and can be turned on by pressing either the Select, Left, or Right indicator button on the LCD panel.

- The LCD backlight remains off if LCD messaging is turned off through the iDRAC utility, the LCD panel, or other tools.

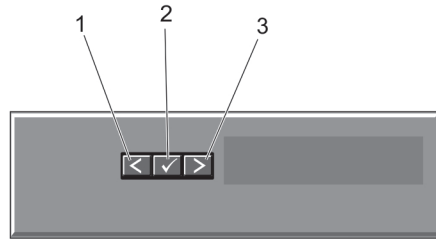



Figure 5. LCD Panel Features

Item	Button	Description
1	Left	Moves the cursor back in one-step increments.
2	Select	Selects the menu item highlighted by the cursor.
3	Right	Moves the cursor forward in one-step increments. During message scrolling: <ul style="list-style-type: none"> • Press once to increase scrolling speed. • Press again to stop. • Press again to return to default scrolling speed. • Press again to repeat the cycle.

Home Screen

The Home screen displays user-configurable information about the system. This screen is displayed during normal system operation when there are no status messages or errors. When the system is in standby mode, the LCD backlight turns off after five minutes of inactivity if there are no error messages. Press one of the three navigation buttons (Select, Left, or Right) to view the Home screen.

To navigate to the Home screen from another menu, continue to select the up arrow  until the Home icon  is displayed, and then select the Home icon.

From the Home screen, press the Select button to enter the main menu.

Setup Menu

 **NOTE:** When you select an option in the Setup menu, you must confirm the option before proceeding to the next action.

Option	Description
iDRAC	Select DHCP or Static IP to configure the network mode. If Static IP is selected, the available fields are IP , Subnet (Sub) , and Gateway (Gtw) . Select Setup DNS to enable DNS and to view domain addresses. Two separate DNS entries are available.
Set error	Select SEL to display LCD error messages in a format that matches the IPMI description in the SEL. This is useful when trying to match an LCD message with an SEL entry. Select Simple to display LCD error messages in a simplified user-friendly description. See System Error Messages for a list of messages in this format.

Option	Description
Set home	Select the default information to be displayed on the LCD Home screen. See View Menu to see the options and option items that can be set as the default on the Home screen.

View Menu

 **NOTE:** When you select an option in the View menu, you must confirm the option before proceeding to the next action.

Option	Description
iDRAC IP	Displays the IPv4 or IPv6 addresses for the iDRAC7. Addresses include DNS (Primary and Secondary) , Gateway , IP , and Subnet (IPv6 does not have Subnet).
MAC	Displays the MAC addresses for iDRAC , iSCSI , or Network devices.
Name	Displays the name of the Host , Model , or User String for the system
Number	Displays the Asset tag or the Service tag for the system.
Power	Displays the power output of the system in BTU/hr or Watts. The display format can be configured in the Set home submenu of the Setup menu.
Temperature	Displays the temperature of the system in Celsius or Fahrenheit. The display format can be configured in the Set home submenu of the Setup menu.

Diagnostic Indicators

 **NOTE:** Systems with cabled hard drives support diagnostic indicators.

The diagnostic indicators on the system front panel display error status during system startup.

 **NOTE:** No diagnostic indicators are lit when the system is switched off. To start the system, plug it into a working power source and press the power button.

The following section describes system conditions and possible corrective actions associated with these indicators:



Health Indicator

Condition	Corrective Action
If the system is on, and in good health, the indicator lights solid blue.	None required.
The indicator blinks amber if the system is on or in standby, and any error exists (for example, a failed fan or hard drive)	See the System Event Log or system messages for the specific issue. Invalid memory configurations can cause the system to halt at startup without any video output. See Getting Help .



Hard-drive Indicator

Condition

The indicator lights green to indicate hard-drive activity.

Corrective Action

None required.



Electrical Indicator

Condition

The indicator blinks amber if the system experiences an electrical error (for example, voltage out of range, or a failed power supply or voltage regulator).

Corrective Action

See the System Event Log or system messages for the specific issue. If it is due to a problem with the power supply, check the LED on the power supply. Re-seat the power supply by removing and reinstalling it. If the problem persists, see [Getting Help](#).



Temperature Indicator

Condition

The indicator blinks amber if the system experiences a thermal error (for example, a temperature out of range or fan failure).

Corrective Action

Ensure that none of the following conditions exist:

- A cooling fan is removed or has failed.
- System cover, cooling shroud, EMI filler panel, memory-module blank, or back-filler bracket is removed.
- Ambient temperature is too high.
- External airflow is obstructed.

See [Getting Help](#).



Memory Indicator

Condition

The indicator blinks amber if a memory error occurs.

Corrective Action

See the system event log or system messages for the location of the failed memory. Reinstall the memory device. If the problem persists, see [Getting Help](#).



PCIe Indicator

Condition

The indicator blinks amber if a PCIe card experiences an error.

Corrective Action

Restart the system. Update any required drivers for the PCIe card. Re-install the card. If the problem persists, see [Getting Help](#).

Hard-Drive Indicator Patterns



Figure 6. Hard-Drive Indicators

1. hard-drive activity indicator (green)
2. hard-drive status indicator (green and amber)

NOTE: If the hard drive is in Advanced Host Controller Interface (AHCI) mode, the status indicator (on the right side) does not function and remains off.

Drive-Status Indicator Pattern (RAID Only)

Condition

Blinks green two times per second

Identifying drive or preparing for removal

Off

Drive ready for insertion or removal



NOTE: The drive status indicator remains off until all hard drives are initialized after the system is turned on. Drives are not ready for insertion or removal during this time.

Blinks green, amber, and off

Predicted drive failure

Blinks amber four times per second

Drive failed

Blinks green slowly

Drive rebuilding

Steady green

Drive online

Drive-Status Indicator Pattern (RAID Only)	Condition
Blinks green three seconds, amber three seconds, and off six seconds	Rebuild aborted

Back-Panel Features And Indicators

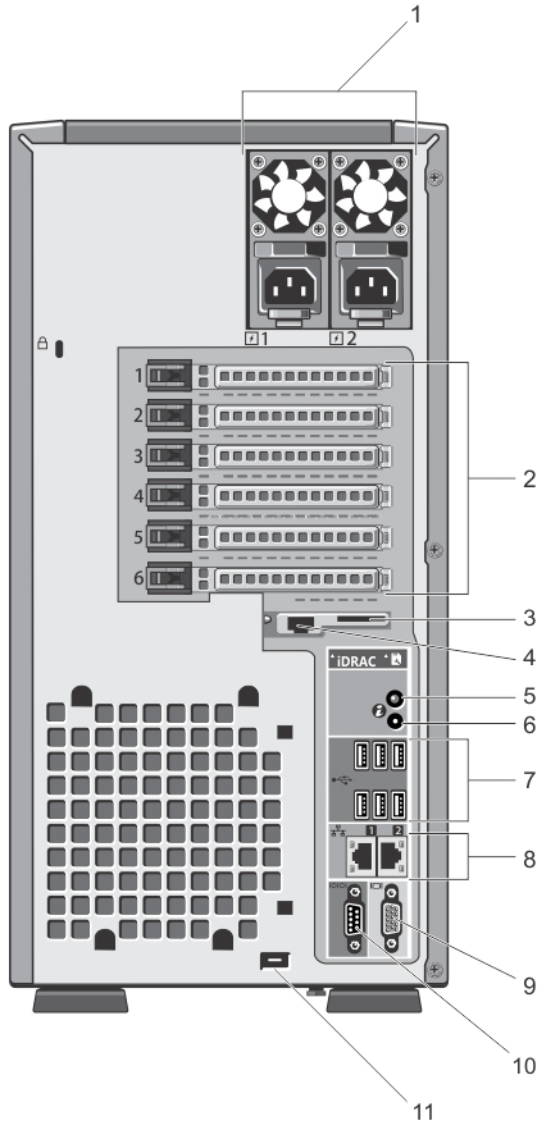









Figure 7. Back-Panel Features and Indicators

Item	Indicator, Button, or Connector	Icon	Description
1	Power supplies (PSU1 and PSU2)		<p>Redundant power supply Up to two 495 W or 750 W AC redundant power supplies.</p> <p>Non-redundant power supply One 350 W non-redundant AC power supply.</p> <p> NOTE: Non-redundant power supply is supported in systems with cabled hard drives and systems with an x8 backplane.</p>
2	PCIe expansion card slots (5)		Allow you to connect up to five full-height PCIe expansion cards.
3	vFlash media card slot		Allows you to insert a vFlash media card.
4	iDRAC7 Enterprise port		<p>Dedicated management port.</p> <p> NOTE: The port is available for use only if the iDRAC7 Enterprise license is installed on your system.</p>
5	System identification button		<p>The identification buttons on the front and back panels can be used to locate a particular system within a rack. When one of these buttons is pressed, the LCD panel on the front and the system status indicator on the back flash until one of the buttons is pressed again.</p> <p>Press to toggle the system ID on and off.</p> <p>If the system stops responding during POST, press and hold the system ID button for more than five seconds to enter the BIOS progress mode.</p> <p>To reset iDRAC (if not disabled in F2 iDRAC setup), press and hold for more than 15 seconds.</p>
6	System identification connector		Allows you to connect the optional system status indicator assembly through the optional cable management arm.
7	USB connectors (6)		Allow you to connect USB devices to the system. The ports are USB 2.0-compliant.
8	Ethernet connectors (2)		Two integrated 10/100/1000 Mbps NIC connectors.
9	Video connector		Allows you to connect a VGA display to the system.
10	Serial connector		Allows you to connect a serial device to the system.
11	External cooling fan power cable slot		Slot for routing the power cable of the optional external cooling fan into the chassis.

NIC Indicator Codes

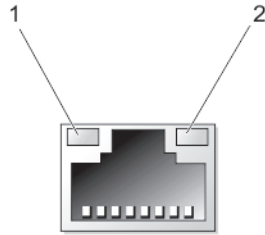

Figure 8. NIC Indicator

1. link indicator
2. activity indicator

Indicator	Indicator Code
Link and activity indicators are off	The NIC is not connected to the network.
Link indicator is green	The NIC is connected to a valid network at its maximum port speed (1 Gbps or 10 Gbps).
Link indicator is amber	The NIC is connected to a valid network at less than its maximum port speed.
Activity indicator is blinking green	Network data is being sent or received.

Power Indicator Codes For Redundant Power Supply

Each redundant AC power supply has an illuminated translucent handle to show whether power is present or whether a power fault has occurred.

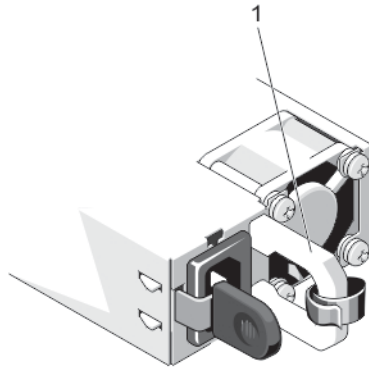





Figure 9. Redundant AC Power Supply Status Indicator

1. AC power supply status handle

Power Indicator Pattern	Condition
Not lit	Power is not connected.
Green	A valid power source is connected to the power supply and the power supply is operational.
Flashing amber	<p>Indicates a problem with the power supply.</p> <p> CAUTION: When correcting a power supply mismatch, replace only the power supply with the flashing indicator. Swapping the opposite power supply to make a matched pair can result in an error condition and unexpected system shutdown. To change from a High Output configuration to a Low Output configuration or vice versa, you must power down the system.</p> <p> CAUTION: AC power supplies support both 220 V and 110 V input voltages. When two identical power supplies receive different input voltages, they can output different wattages, and trigger a mismatch.</p> <p> CAUTION: If two power supplies are used, they must be of the same type and have the same maximum output power.</p>
Flashing green	<p>When hot-adding a power supply, this indicates that the power supply is mismatched with the other power supply (in terms of efficiency, feature set, health status, and supported voltage). Replace the power supply that has the flashing indicator with a power supply that matches the capacity of the other installed power supply.</p>

Power Indicator Codes For Non-Redundant Power Supply

Press the self-diagnostic button to perform a quick health check on the non-redundant power supply of the system.

Diagnostic Indicator Pattern	Condition
Not lit	Power is not connected or power supply is faulty.
Green	A valid power source is connected to the power supply and the power supply is operational.

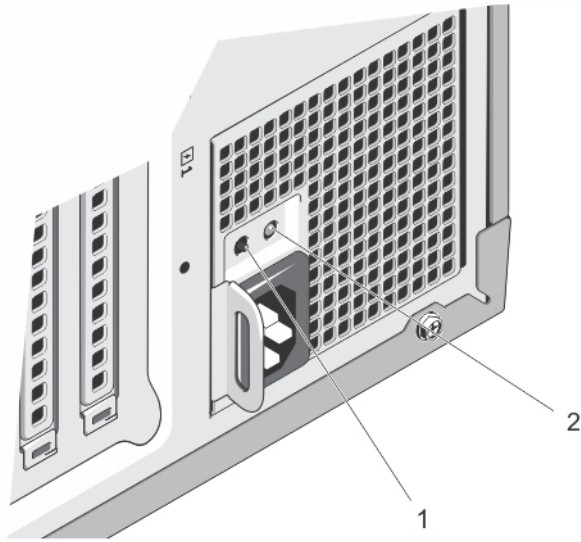

Figure 10. Non-Redundant AC Power Supply Status Indicator and Self-Diagnostic Button

1. self-diagnostic button
2. AC power supply status indicator

Other Information You May Need

⚠ WARNING: See the safety and regulatory information that shipped with your system. Warranty information may be included within this document or as a separate document.

- The *Getting Started Guide* provides an overview of setting up your system, and technical specifications. This document is available online at www.dell.com/support/manuals.
- The rack documentation included with your rack solution describes how to install your system into a rack, if required.
- Any media that ships with your system that provides documentation and tools for configuring and managing your system, including those pertaining to the operating system, system management software, system updates, and system components that you purchased with your system.
- For the full name of an abbreviation or acronym used in this document, see the Glossary at www.dell.com/support/manuals.

📄 NOTE: Always check for updates on www.dell.com/support/manuals and read the updates first because they often supersede information in other documents.

Using The System Setup And Boot Manager

System Setup enables you to manage your system hardware and specify BIOS-level options.

The following keystrokes provide access to system features during startup:

Keystroke	Description
<F2>	Enters the System Setup.
<F10>	Enters System Services, which opens the Dell Lifecycle Controller 2 (LC2). The Dell LC2 supports systems management features such as operating system deployment, hardware diagnostics, firmware updates, and platform configuration, using a graphical user interface. The exact LC2 feature set is determined by the iDRAC license purchased. For more information, see the Dell LC2 documentation.
<F11>	Enters the BIOS Boot Manager or the Unified Extensible Firmware Interface (UEFI) Boot Manager, depending on the system's boot configuration
<F12>	Starts Preboot Execution Environment (PXE) boot.

From the System Setup, you can:

- Change the NVRAM settings after you add or remove hardware
- View the system hardware configuration
- Enable or disable integrated devices
- Set performance and power management thresholds
- Manage system security

You can access the System Setup using the:

- Standard graphical browser, which is enabled by default
- Text browser, which is enabled using **Console Redirection**

To enable **Console Redirection**, in **System Setup**, select **System BIOS** → **Serial Communication screen** → **Serial Communication**, select **On with Console Redirection**.

 **NOTE:** By default, help text for the selected field is displayed in the graphical browser. To view the help text in the text browser, press <F1>.

Choosing The System Boot Mode

System Setup enables you to specify the boot mode for installing your operating system:

- BIOS boot mode (the default) is the standard BIOS-level boot interface.

- UEFI boot mode is an enhanced 64-bit boot interface based on Unified Extensible Firmware Interface (UEFI) specifications that overlays the system BIOS.

You must select the boot mode in the **Boot Mode** field of the **Boot Settings** screen of System Setup. Once you specify the boot mode, the system boots in the specified boot mode and you then proceed to install your operating system from that mode. Thereafter, you must boot the system in the same boot mode (BIOS or UEFI) to access the installed operating system. Trying to boot the operating system from the other boot mode will cause the system to halt at startup.

 **NOTE:** Operating systems must be UEFI-compatible to be installed from the UEFI boot mode. DOS and 32-bit operating systems do not support UEFI and can only be installed from the BIOS boot mode.

 **NOTE:** For the latest information on supported operating systems, go to dell.com/ossupport.

Entering System Setup

1. Turn on or restart your system.
2. Press **<F2>** immediately after you see the following message:

```
<F2> = System Setup
```

If your operating system begins to load before you press **<F2>**, allow the system to finish booting, and then restart your system and try again.

Responding To Error Messages

If an error message is displayed while the system is booting, make a note of the message. For more information, see System Error Messages.

 **NOTE:** After installing a memory upgrade, it is normal for your system to display a message the first time you start your system.

Using The System Setup Navigation Keys

Keys	Action
Up arrow	Moves to the previous field.
Down arrow	Moves to the next field.
<Enter>	Allows you to type in a value in the selected field (if applicable) or follow the link in the field.
Spacebar	Expands or collapses a drop-down menu, if applicable.
<Tab>	Moves to the next focus area.
	 NOTE: For the standard graphics browser only.
<Esc>	Moves to the previous page till you view the main screen. Pressing <Esc> in the main screen displays a message that prompts you to save any unsaved changes and restarts the system.
<F1>	Displays the System Setup help file.

 **NOTE:** For most of the options, any changes that you make are recorded but do not take effect until you restart the system.

System Setup Options

System Setup Main Screen

 **NOTE:** Press <Alt><F> to reset the BIOS or UEFI settings to their default settings.

Menu Item	Description
System BIOS	This option is used to view and configure BIOS settings.
iDRAC Settings	This option is used to view and configure iDRAC settings.
Device Settings	This option is used to view and configure device settings.

System BIOS Screen

 **NOTE:** The options for System Setup change based on the system configuration.

 **NOTE:** System Setup defaults are listed under their respective options in the following sections, where applicable.



Menu Item	Description
System Information	Displays information about the system such as the system model name, BIOS version, Service Tag, and so on.
Memory Settings	Displays information and options related to installed memory.
Processor Settings	Displays information and options related to the processor such as speed, cache size, and so on.
SATA Settings	Displays options to enable or disable the integrated SATA controller and ports.
Boot Settings	Displays options to specify the boot mode (BIOS or UEFI). Enables you to modify UEFI and BIOS boot settings.
Integrated Devices	Displays options to enable or disable integrated device controllers and ports, and to specify related features and options.
Serial Communication	Displays options to enable or disable the serial ports and specify related features and options.
System Profile Settings	Displays options to change the processor power management settings, memory frequency, and so on.
System Security	Displays options to configure the system security settings like, system password, setup password, TPM security, and so on. It also enables or disables support for local BIOS update, the power and NMI buttons on the system.
Miscellaneous Settings	Displays options to change the system date, time, and so on.

System Information Screen

Menu Item	Description
System Model Name	Displays the system model name.



Menu Item	Description
System BIOS Version	Displays the BIOS version installed on the system.
System Service Tag	Displays the system Service Tag.
System Manufacturer	Displays the name of system manufacturer.
System Manufacturer Contact Information	Displays the contact information of the system manufacturer.

Memory Settings Screen

Menu Item	Description
System Memory Size	Displays the amount of memory installed in the system.
System Memory Type	Displays the type of memory installed in the system.
System Memory Speed	Displays the system memory speed.
System Memory Voltage	Displays the system memory voltage.
Video Memory	Displays the amount of video memory.
System Memory Testing	Specifies whether system memory tests are run during system boot. Options are Enabled and Disabled . By default, the System Memory Testing option is set to Disabled .
Memory Operating Mode	Specifies the memory operating mode. The options available depending on the memory configuration of your system are Optimizer Mode , Advanced ECC Mode , Mirror Mode , Spare Mode , Spare with Advanced ECC Mode , and Dell Fault Resilient Mode . By default, the Memory Operating Mode option is set to Optimizer Mode . <ul style="list-style-type: none">  NOTE: The Memory Operating Mode can have different defaults and available options based on the memory configuration.  NOTE: The Dell Fault Resilient Mode establishes an area of memory that is fault resilient. This mode can be used by an operating system that supports the feature to load critical applications or enables the operating system kernel to maximize system availability.
Node Interleaving	If this field is Enabled , memory interleaving is supported if a symmetric memory configuration is installed. If Disabled , the system supports Non-Uniform Memory architecture (NUMA) (asymmetric) memory configurations. By default, Node Interleaving option is set to Disabled .

Processor Settings Screen





Menu Item	Description
Logical Processor	Allows you to enable or disable logical processors and display the number of logical processors. If the Logical Processor option is set to Enabled , the BIOS displays all the logical processors. If this option is set to Disabled , the BIOS only displays one logical processor per core. By default, the Logical Processor option is set to Enabled .
QPI Speed	Allows you to set the QuickPath Interconnect data rate settings. By default, the QPI Speed option is set to Maximum data rate .

Menu Item	Description
	 NOTE: The QPI speed option displays only when both the processors are installed.
Alternate RTID (Requestor Transaction ID) Setting	Allows you to allocate more RTIDs to the remote socket increasing cache performance between the sockets or work in normal mode for NUMA. By default, the Alternate RTID (Requestor Transaction ID) Setting is set to Disabled .
Virtualization Technology	Allows you to enable or disable the additional hardware capabilities provided for virtualization. By default, the Virtualization Technology option is set to Enabled .
Adjacent Cache Line Prefetch	Allows you to optimize the system for applications that require high utilization of sequential memory access. By default, the Adjacent Cache Line Prefetch option is set to Enabled . You can disable this option for applications that require high utilization of random memory access.
Hardware Prefetcher	Allows you to enable or disable hardware prefetcher. By default, the Hardware Prefetcher option is set to Enabled .
DCU Streamer Prefetcher	Allows you to enable or disable Data Cache Unit streamer prefetcher. By default, the DCU Streamer Prefetcher option is set to Enabled .
DCU IP Prefetcher	Allows you to enable or disable Data Cache Unit IP prefetcher. By default, the DCU IP Prefetcher option is set to Enabled .
Execute Disable	Allows you enable or disable execute disable memory protection technology. By default, the Execute Disable option is set to Enabled .
Logical Processor Idling	Allows you to enable or disable the OS capability to put logical processors in the idling state in order to reduce power consumption. By default, the option is set to Disabled .
Number of Cores per Processor	Allows you to control the number of enabled cores in each processor. By default, the Number of Cores per Processor option is set to All .
Processor 64-bit Support	Specifies if the processor(s) support 64-bit extensions.
Processor Core Speed	Displays the maximum core frequency of the processor.
Processor Bus Speed	Displays the bus speed of the processors.  NOTE: The processor bus speed option displays only when both the processors are installed.
Processor 1	 NOTE: The following settings are displayed for each processor installed in the system.
Family-Model-Stepping	Displays the family, model and stepping of the processor as defined by Intel.
Brand	Displays the brand name reported by the processor.
Level 2 Cache	Displays the total L2 cache.
Level 3 Cache	Displays the total L3 cache.
Number of Cores	Displays the number of cores per processor.



SATA Settings Screen

Menu Item	Description
Embedded SATA	Allows the embedded SATA to be set to Off , ATA , AHCI , or RAID modes. By default, the Embedded SATA option is set to AHCI .
Port A	Auto enables BIOS support for the device attached to SATA port A. Off disables BIOS support for the device. By default, Port A is set to Auto .
Port B	Auto enables BIOS support for the device attached to SATA port B. Off disables BIOS support for the device. By default, Port B is set to Auto .
Port C	Auto enables BIOS support for the device attached to SATA port C. Off disables BIOS support for the device. By default, Port C is set to Auto .
Port D	Auto enables BIOS support for the device attached to SATA port D. Off disables BIOS support for the device. By default, Port D is set to Auto .
Port E	Auto enables BIOS support for the device attached to SATA port E. Off disables BIOS support for the device. By default, Port E is set to Auto .
Port F	Auto enables BIOS support for the device attached to SATA port F. Off disables BIOS support for the device. By default, Port F is set to Auto .

Boot Settings Screen



Menu Item	Description
Boot Mode	<p>Allows you to set the boot mode of the system.</p> <p> CAUTION: Switching the boot mode may prevent the system from booting if the operating system is not installed in the same boot mode.</p> <p>If the operating system supports UEFI, you can set this option to UEFI. Setting this field to BIOS allows compatibility with non-UEFI operating systems. By default, the Boot Mode option is set to BIOS.</p> <p> NOTE: Setting this field to UEFI disables BIOS Boot Settings menu. Setting this field to BIOS disables the UEFI Boot Settings menu.</p>
Boot Sequence Retry	Allows you to enable or disable the boot sequence retry feature. If this field is enabled and the system fails to boot, the system reattempts the boot sequence after 30 seconds. By default, the Boot Sequence Retry option is set to Disabled .
BIOS Boot Settings	Allows you to enable or disable BIOS Boot options.  NOTE: This option is enabled only if the boot mode is BIOS.
UEFI Boot Settings	Allows you to enable or disable UEFI Boot options. The Boot options include IPv4 PXE and IPv6 PXE . By default, the UEFI PXE boot protocol is set to IPv4 .  NOTE: This option is enabled only if the boot mode is UEFI.
One-Time Boot	Allows you to enable or disable a one-time boot from a selected device.

Integrated Devices Screen



Menu Item	Description
User Accessible USB Ports	Allows you enable or disable the user accessible USB ports. Selecting Only Back Ports On disables the front USB ports and selecting All Ports Off disables both front and back USB ports. By default, the User Accessible USB Ports option is set to All Ports On .
Internal USB Port	Allows you to enable or disable the internal USB port. By default, the Internal USB Port option is set to On .
Internal SD Card Port	Enables or disables the system's internal SD card port. By default, Internal SD Card Port option is set to On .  NOTE: This option is displayed only if IDSDM is installed on the system board.
Internal SD Card Redundancy	If set to Mirror mode, data is written on both SD cards. If any one of the SD card fails, data is written to the active SD card. Data from this card is copied to the replacement SD card at the next boot. By default, Internal SD Card Redundancy option is set to Mirror .  NOTE: This option is displayed only if IDSDM is installed on the system board.
Embedded NIC1 & NIC2	Allows you to enable or disable Embedded NIC1 & NIC2 . By default, the Embedded NIC1 & NIC2 option is set to Enabled .
OS Watchdog Timer	Allows you to enable or disable the OS watchdog timer. When this field is enabled, the operating system initializes the timer and the OS watchdog timer helps in recovering the operating system. By default, the OS Watchdog Timer option is set to Disabled .
Embedded Video Controller	Allows you to enable or disable the Embedded Video Controller . By default, the embedded video controller is Enabled .
SR-IOV Global Enable	Allows you to enable or disable the BIOS configuration of Single Root I/O Virtualization (SR-IOV) devices. By default, the SR-IOV Global Enable option is set to Disabled .
Memory Mapped I/O above 4GB	Allows you to enable support for PCIe devices that require large amounts of memory. By default, the option is set to Enabled .
Slot Disablement	Allows you to enable or disable available PCIe slots on your system. The Slot Disablement feature controls the configuration of PCIe cards installed in the specified slot.  CAUTION: Slot disablement must be used only when the installed peripheral card is preventing booting into the Operating System or causing delays in system startup. If the slot is disabled, both the Option ROM and UEFI driver are disabled.

Serial Communications Screen

Menu Item	Description
Serial Communication	Allows you to select serial communication devices (Serial Device 1 and Serial Device 2) in the BIOS. BIOS console redirection can also be enabled and the port address used can be specified. By default, Serial Communication option is set to On without Console Redirection .

Menu Item	Description
Serial Port Address	<p>Allows you to set the port address for serial devices. By default, the Serial Port Address option is set to Serial Device 1=COM2, Serial Device 2=COM1.</p> <p> NOTE: Only Serial Device 2 can be used for Serial Over LAN (SOL). To use console redirection by SOL, configure the same port address for console redirection and the serial device.</p>
External Serial Connector	<p>Allows you to associate the external serial connector to serial device 1, serial device 2, or remote access device. By default, the External Serial Connector option is set to Serial Device1.</p> <p> NOTE: Only Serial Device 2 can be used for SOL. To use console redirection by SOL, configure the same port address for console redirection and the serial device.</p>
Failsafe Baud Rate	<p>Displays the failsafe baud rate for console redirection. The BIOS attempts to determine the baud rate automatically. This failsafe baud rate is used only if the attempt fails and the value must not be changed. By default, the Failsafe Baud Rate option is set to 11520.</p>
Remote Terminal Type	<p>Allows you to set the remote console terminal type. By default, the Remote Terminal Type option is set to VT 100/VT 220.</p>
Redirection After Boot	<p>Allows you to enable or disable to the BIOS console redirection when the operating system is loaded. By default, the Redirection After Boot option is set to Enabled.</p>

System Profile Settings Screen

Menu Item	Description
System Profile	<p>Allows you to set the system profile. If you set the System Profile option to a mode other than Custom, the BIOS automatically sets the rest of the options. You can only change the rest of the options if the mode is set to Custom. By default, the System Profile option is set to Performance Per Watt Optimized (DAPC). DAPC is Dell Active Power Controller.</p> <p> NOTE: The following parameters are available only when the System Profile is set to Custom.</p>
CPU Power Management	<p>Allows you to set the CPU power management. By default, the CPU Power Management option is set to System DBPM (DAPC). DBPM is Demand-Based Power Management.</p>
Memory Frequency	<p>Allows you to set the memory frequency. By default, the Memory Frequency option is set to Maximum Performance.</p>
Turbo Boost	<p>Allows you to enable or disable the processor to operate in turbo boost mode. By default, the Turbo Boost option is set to Enabled.</p>
C1E	<p>Allows you to enable or disable the processor to switch to a minimum performance state when it is idle. By default, the C1E option is set to Enabled.</p>
C States	<p>Allows you to enable or disable the processor to operate in all available power states. By default, the C States option is set to Enabled.</p>
Monitor/Mwait	<p>Allows you to enable Monitor/Mwait instructions in the processor. By default, the Monitor/Mwait option is set to Enabled for all system profiles, except Custom.</p> <p> NOTE: This option can be disabled only if the C States option in Custom mode is disabled.</p>

Menu Item	Description
	 NOTE: When C States is enabled in Custom mode, changing the Monitor/Mwait setting does not impact system power/performance.
Memory Patrol Scrub	Allows you to set the memory patrol scrub frequency. By default, the Memory Patrol Scrub option is set to Standard .
Memory Refresh Rate	Allows you to set the memory refresh rate. By default, the Memory Refresh Rate option is set to 1x .
Memory Operating Voltage	Allows you to set the DIMM voltage selection. When set to Auto , the system automatically sets the system voltage to the optimal setting based on the DIMM capacity and the number of DIMMs installed. By default, the Memory Operating Voltage option is set to Auto .
Collaborative CPU Performance Control	When set to enabled, the CPU power management is controlled by the OS DBPM and the System DBPM (DAPC). By default, the option is set to Disabled

System Security Screen

Menu Item	Description
Intel AES-NI	The Intel AES-NI option improves the speed of applications by performing encryption and decryption using the Advanced Encryption Standard Instruction Set and is set to Enabled by default.
System Password	Allows you to set the system password. This option is set to Enabled by default and is read-only if the password jumper is not installed in the system.
Setup Password	Allows you to set the setup password. This option is read-only if the password jumper is not installed in the system.
Password Status	Allows you to lock the system password. By default, the Password Status option is set to Unlocked .
TPM Security	Allows you to control the reporting mode of the Trusted Platform Module (TPM). By default, the TPM Security option is set to Off . You can only modify the TPM Status, TPM Activation , and Intel TXT fields if the TPM Status field is set to either On with Pre-boot Measurements or On without Pre-boot Measurements .
TPM Activation	Allows you to change the operational state of the TPM. By default, the TPM Activation option is set to No Change .
TPM Status	Displays the TPM status.
TPM Clear	 CAUTION: Clearing the TPM results in loss of all keys in the TPM. The loss of TPM keys may affect booting to the operating system. Allows you to clear all the contents of the TPM. By default, the TPM Clear option is set to No .
Intel TXT	Allows you enable or disable Intel Trusted Execution Technology. To enable Intel TXT , Virtualization Technology must be enabled and TPM Security must be Enabled with Pre-boot measurements. By default, the Intel TXT option is set to Off .
Power Button	Allows you to enable or disable the power button on the front of the system. By default, the Power Button option is set to Enabled .

Menu Item	Description
NMI Button	Allows you to enable or disable the NMI button on the front of the system. By default, the NMI Button option is set to Disabled .
AC Power Recovery	Allows you to set how the system reacts after AC power is restored to the system. By default, the AC Power Recovery option is set to Last .
AC Power Recovery Delay	Allows you to set how the system supports staggering of power up after AC power is restored to the system. By default, the AC Power Recovery Delay option is set to Immediate .
User Defined Delay (60s to 240s)	Allows you to set the User Defined Delay when the User Defined option for AC Power Recovery Delay is selected.

Miscellaneous Settings

Menu Item	Description
System Time	Allows you to set the time on the system.
System Date	Allows you to set the date on the system.
Asset Tag	Displays the asset tag and allows you to modify it for security and tracking purposes.
Keyboard NumLock	Allows you to set whether the system boots with the NumLock enabled or disabled. By default the Keyboard NumLock is set to On .  NOTE: This field does not apply to 84-key keyboards.
Report Keyboard Errors	Allows you to set whether keyboard-related error messages are reported during system boot. By default, the Report Keyboard Errors field is set to Report .
F1/F2 Prompt on Error	Allows you to enable or disable the F1/F2 prompt on error. By default, F1/F2 Prompt on Error is set to Enabled .

System And Setup Password Features

You can create a system password and a setup password to secure your system. To enable creation of the system and setup password, the password jumper must be set to enabled. For more information on the password jumper settings, see System Board Jumper Settings.

System password	This is the password that you must enter before you can boot your system.
Setup password	This is the password that you must enter to access and make changes to the BIOS or UEFI settings of your system.

 **CAUTION:** The password features provide a basic level of security for the data on your system.

 **CAUTION:** Anyone can access the data stored on your system if the system is running and unattended.

 **NOTE:** Your system is shipped with the system and setup password feature disabled.

Assigning A System And/Or Setup Password

 **NOTE:** The password jumper enables or disables the System Password and Setup Password features. For more information on the password jumper settings, see System Board Jumper Settings.

You can assign a new **System Password** and/or **Setup Password** or change an existing **System Password** and/or **Setup Password** only when the password jumper setting is enabled and **Password Status** is **Unlocked**. If the Password Status is **Locked**, you cannot change the System Password and/or Setup Password.

If the password jumper setting is disabled, the existing System Password and Setup Password is deleted and you need not provide the system password to boot the system.

To assign a system and/or setup password:

1. To enter System Setup, press <F2> immediately after a power-on or reboot.
2. In the **System Setup Main Menu**, select **System BIOS** and press <Enter>. The **System BIOS** screen is displayed.
3. In the **System BIOS** screen, select **System Security** and press <Enter>. The **System Security** screen is displayed.
4. In the **System Security** screen, verify that **Password Status** is **Unlocked**.
5. Select **System Password**, enter your system password, and press <Enter> or <Tab>.

Use the following guidelines to assign the system password:

- A password can have up to 32 characters.
- The password can contain the numbers 0 through 9.
- Only lower case letters are valid, upper case letters are not allowed.
- Only the following special characters are allowed: space, ("), (+), (.), (-), (.), (/), (:), (I), (\), (]), (').

A message prompts you to re-enter the system password.

6. Re-enter the system password that you entered earlier and click **OK**.
7. Select **Setup Password**, enter your system password and press <Enter> or <Tab>. A message prompts you to re-enter the setup password.
8. Re-enter the setup password that you entered earlier and click **OK**.
9. Press <Esc> to return to the System BIOS screen. Press <Esc> again, and a message prompts you to save the changes.



 **NOTE:** Password protection does not take effect until the system reboots.

Deleting Or Changing An Existing System And/Or Setup Password

Ensure that the Password jumper is set to enabled and the **Password Status** is **Unlocked** before attempting to delete or change the existing System and/or Setup password. You cannot delete or change an existing System or Setup password if the **Password Status** is **Locked**.

To delete or change the existing System and/or Setup password:

1. To enter System Setup, press <F2> immediately after a power-on or restart.
2. In the **System Setup Main Menu**, select **System BIOS** and press <Enter>. The **System BIOS** screen is displayed.
3. In the **System BIOS Screen**, select **System Security** and press <Enter>. The **System Security** screen is displayed.

4. In the **System Security** screen, verify that **Password Status** is **Unlocked**.
5. Select **System Password**, alter or delete the existing system password and press **<Enter>** or **<Tab>**.
6. Select **Setup Password**, alter or delete the existing setup password and press **<Enter>** or **<Tab>**.
 **NOTE:** If you change the System and/or Setup password a message prompts you to re-enter the new password. If you delete the System and/or Setup password, a message prompts you to confirm the deletion.
7. Press **<Esc>** to return to the System BIOS screen. Press **<Esc>** again, and a message prompts you to save the changes.
 **NOTE:** You can disable password security while logging on to the system. To disable the password security, turn on or reboot your system, type your password and press **<Ctrl><Enter>**.

Using Your System Password To Secure Your System

 **NOTE:** If you have assigned a setup password, the system accepts your setup password as an alternate system password.

1. Turn on or reboot your system.
2. Type your password and press **<Enter>**.

When **Password Status** is **Locked**, type the password and press **<Enter>** when prompted at reboot.

If an incorrect system password is entered, the system displays a message and prompts you to re-enter your password. You have three attempts to enter the correct password. After the third unsuccessful attempt, the system displays an error message that the system has halted and must be powered down.

Even after you shut down and restart the system, the error message is displayed until the correct password is entered.

 **NOTE:** You can use the **Password Status** option in conjunction with the **System Password** and **Setup Password** options to protect your system from unauthorized changes.

Operating With A Setup Password Enabled

If **Setup Password** is **Enabled**, enter the correct setup password before modifying most of the System Setup options.

If you do not enter the correct password in three attempts, the system displays the message

```
Invalid Password! Number of unsuccessful password attempts: <x> System Halted!  
Must power down.
```

Even after you shut down and restart the system, the error message is displayed until the correct password is entered. The following options are exceptions:

- If **System Password** is not **Enabled** and is not locked through the **Password Status** option, you can assign a system password.
- You cannot disable or change an existing system password.

 **NOTE:** You can use the Password Status option in conjunction with the **Setup Password** option to protect the system password from unauthorized changes.

Entering The UEFI Boot Manager

 **NOTE:** Operating systems must be 64-bit UEFI-compatible (for example, Microsoft Windows Server 2008 x64 version) to be installed from the UEFI boot mode. DOS and 32-bit operating systems can only be installed from the BIOS boot mode.

The Boot Manager enables you to:

- Add, delete, and arrange boot options.
- Access System Setup and BIOS-level boot options without restarting.

To enter the Boot Manager:

1. Turn on or restart your system.
2. Press **<F11>** after you see the following message:
`<F11> = UEFI Boot Manager`

If your operating system begins to load before you press **<F11>**, allow the system to finish booting, and then restart your system and try again.

Using The Boot Manager Navigation Keys

Key	Description
Up arrow	Moves to the previous field.
Down arrow	Moves to the next field.
<Enter>	Allows you to type in a value in the selected field (if applicable) or follow the link in the field.
Spacebar	Expands or collapses a drop-down list, if applicable.
<Tab>	Moves to the next focus area.
	 NOTE: For the standard graphics browser only.
<Esc>	Moves to the previous page till you view the main screen. Pressing <Esc> in the main screen exits the Boot Manager and proceeds with system boot.

 **NOTE:** For most of the options, any changes that you make are recorded but do not take effect until you restart the system.

Boot Manager Screen

Menu Item	Description
Continue Normal Boot	The system attempts to boot to devices starting with the first item in the boot order. If the boot attempt fails, the system continues with the next item in the boot order until the boot is successful or no more boot options are found.
BIOS Boot Menu	Displays the list of available BIOS boot options (marked with asterisks). Select the boot option you wish to use and press <Enter>.
UEFI Boot Menu	Displays the list of available UEFI boot options (marked with asterisks). Select the boot option you wish to use and press <Enter>. The UEFI Boot Menu enables you to Add Boot Option , Delete Boot Option , or Boot From File .
Driver Health Menu	Displays a list of the drivers installed on the system and their health status.
Launch System Setup	Enables you to access the System Setup.
System Utilities	Enables you to access the BIOS Update File Explorer, run the Dell Diagnostics program, and reboot the system.

UEFI Boot Menu

Menu Item	Description
Select UEFI Boot Option	Displays the list of available UEFI boot options (marked with asterisks), select the boot option you wish to use and press <Enter>.
Add Boot Option	Adds a new boot option.
Delete Boot Option	Deletes an existing boot option.
Boot From File	Sets a one-time boot option not included in the boot option list.

Embedded System Management

The Dell Lifecycle Controller provides advanced embedded systems management throughout the server's lifecycle. The Lifecycle Controller can be started during the boot sequence and can function independently of the operating system.

 **NOTE:** Certain platform configurations may not support the full set of features provided by the Lifecycle Controller.

For more information about setting up the Lifecycle Controller, configuring hardware and firmware, and deploying the operating system, see the Lifecycle Controller documentation at dell.com/support/manuals.

iDRAC Settings Utility

The iDRAC Settings utility is an interface to setup and configure the iDRAC parameters using UEFI. You can enable or disable various iDRAC parameters using the iDRAC Settings Utility.

 **NOTE:** Accessing some of the features on the iDRAC Settings Utility requires the iDRAC7 Enterprise License upgrade.

For more information on using iDRAC, see the *iDRAC7 User's Guide* under **Software** → **Systems Management** → **Dell Remote Access Controllers**, at dell.com/support/manuals.

Entering The iDRAC Settings Utility

1. Turn on or restart the managed system.
2. Press <F2> during Power-on Self-test (POST).
3. In the **System Setup Main Menu** page, click **iDRAC Settings**.
The iDRAC Settings screen is displayed.

Changing The Thermal Settings

The iDRAC Settings utility enables you to select and customize the thermal control settings for your system.

1. Enter the iDRAC Settings utility.
2. Under **iDRAC Settings** → **Thermal** → **User Option**, select between the following options:
 - Default
 - Maximum Exhaust Temperature
 - Fan Speed Offset

 **NOTE:** When the **User Option** is set to the default **Auto** setting, the user option cannot be modified.

3. Set the **Maximum Air Exhaust Temperature** or the **Fan Speed Offset** fields.
4. Click **Back** → **Finish** → **Yes**.

Installing System Components

Recommended Tools

You may need the following items to perform the procedures in this section:

- Key to the system keylock
- #1 and #2 Phillips screwdrivers
- Wrist grounding strap connected to ground

Front Bezel (Optional)

Installing The Front Bezel

1. Insert the bezel tabs into the bezel tab slots in the chassis.
2. Press the top end of the bezel into the chassis until the bezel locks into place.
3. Insert the bezel key in the keylock.
4. Keeping the keylock pressed with the bezel key, rotate the keylock to the locked position.

 **NOTE:** The bezel key can be found taped to the inside of the bezel.

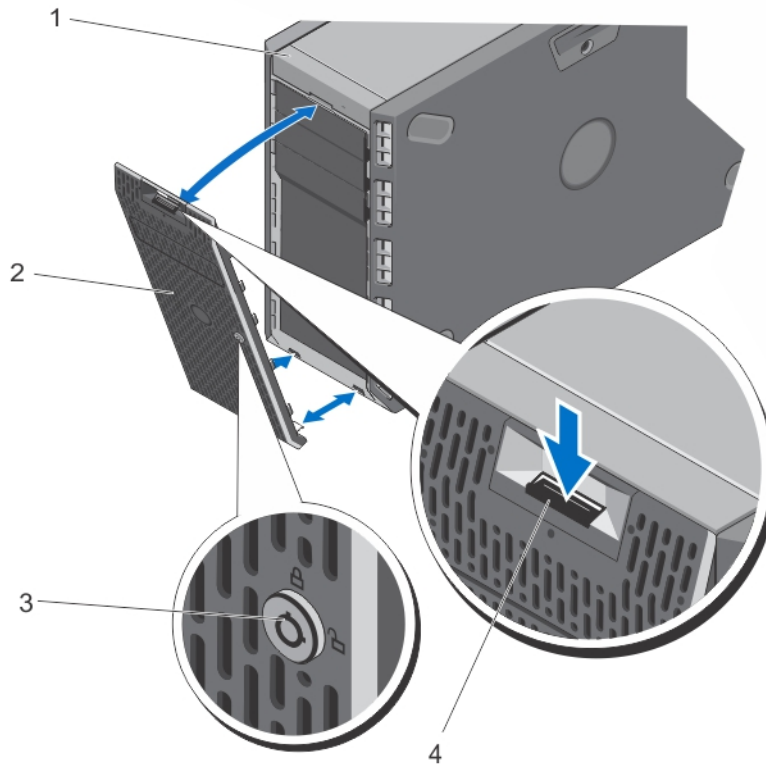

Figure 11. Removing and Installing the Front Bezel

1. system
2. front bezel
3. keylock
4. release latch

Removing The Front Bezel

1. Insert the bezel key in the keylock.
2. Keeping the keylock pressed with the bezel key, rotate the keylock to the unlocked position.
3. Press down on the release latch at the top of the bezel.
4. Rotate the top end of the bezel away from the system.
5. Unhook the bezel tabs from the slots on the front of the chassis.

System Feet—Tower Mode

The system feet provide stability to the system in the tower mode.

Removing The System Feet

NOTE: It is recommended that you remove the system feet only when you are converting the system from the tower mode to the rack mode, or when you are replacing the system feet with the wheel assembly.

1. Rotate the system feet inward.
2. Lay the system on its side on a flat, stable surface.
3. Remove the screws securing the system feet to the base of the tower.

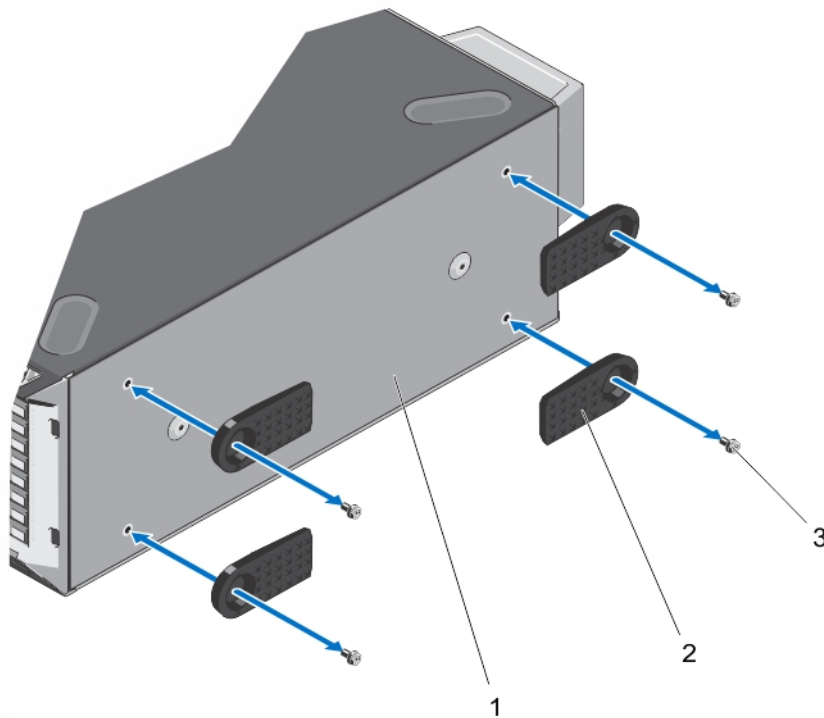

Figure 12. Removing and Installing the System Feet

1. base of the tower
2. system feet (4)
3. screws (4)

Installing The System Feet

1. Lay the system on its side on a flat, stable surface.
2. Secure the system feet to the base of the tower using the screws.
3. Place the system upright on a flat, stable surface and turn the system feet outward.

Wheel Assembly (Optional)—Tower Mode

The wheel assembly provides mobility to the system in the tower mode.

The wheel assembly consists of the following:

- Wheel assembly units (front and back)
- Two screws for the wheel assembly units
- Support unit with two screws

Removing The Wheel Assembly

1. Lay the system on a sturdy, stable surface with the wheel assembly extending off the edge of the surface.
2. Remove the two screws securing the support unit to the base of the chassis and pull out the support unit.
3. Remove the screw securing the front wheel assembly unit to the base of the chassis.
4. Offset the front wheel assembly unit slightly to the back of the system to release the retention hooks, and pull out the front wheel assembly unit.
5. Remove the screw securing the back wheel assembly unit to the base of the chassis.
6. Offset the back wheel assembly unit slightly to the front of the system to release the retention hooks, and pull out the back wheel assembly unit.
7. If you are not replacing the wheel assembly, install the system feet.
8. Place the system on a sturdy, stable surface and if applicable, rotate the system feet outward.

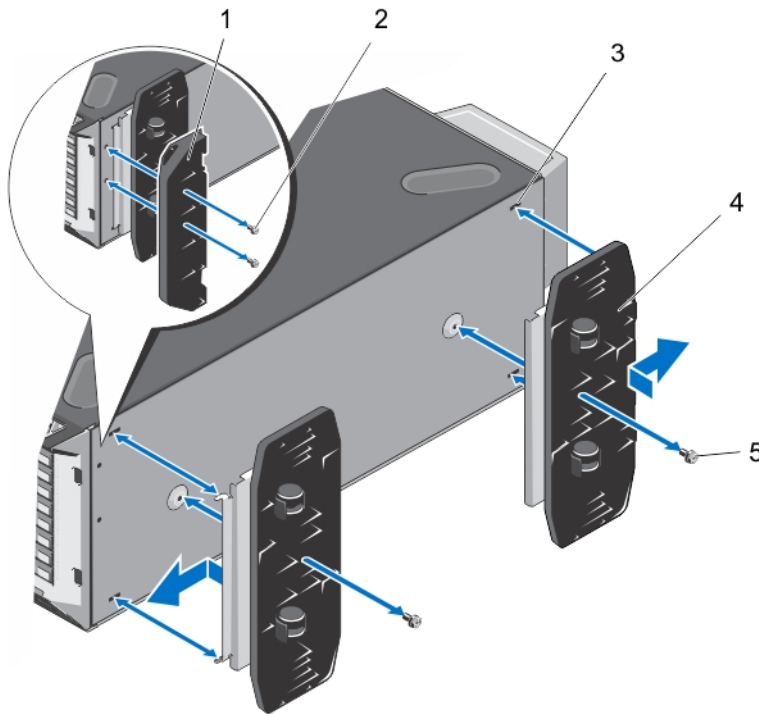

Figure 13. Removing and Installing the Wheel Assembly

- | | |
|-----------------------------------|----------------------------------|
| 1. support unit | 4. wheel assembly unit (2) |
| 2. screws for support unit (2) | 5. screws for wheel assembly (2) |
| 3. slots on base of the tower (4) | |

Installing The Wheel Assembly

1. If applicable, rotate the system feet inward.
2. Lay the system on its side on a sturdy, stable surface with the base of the system extending off the edge of the surface.
3. If applicable, remove the system feet.
4. Align the two retention hooks on the back wheel assembly unit with the two slots on the base of the chassis, and insert the hooks into the slots.
5. Offset the back wheel assembly slightly to the back of the system and secure the unit in place using a single screw.
6. Align the two retention hooks on the front wheel assembly with the two slots on the base of the chassis, and insert the hooks into the slots.
7. Offset the front wheel assembly slightly to the front and secure the unit in place using a screw.
8. Using two screws, install the support unit on the base of the chassis.
9. Place the system upright on a sturdy, stable surface.

Opening And Closing The System

 **WARNING:** Whenever you need to lift the system, get others to assist you. To avoid injury, do not attempt to lift the system by yourself.

 **WARNING:** Opening or removing the system cover when the system is on may expose you to a risk of electric shock.

 **CAUTION:** Many repairs may only be done by a certified service technician. You should only perform troubleshooting and simple repairs as authorized in your product documentation, or as directed by the online or telephone service and support team. Damage due to servicing that is not authorized by Dell is not covered by your warranty. Read and follow the safety instructions that came with the product.

 **CAUTION:** Do not operate the system without the cover for a duration exceeding five minutes.

Opening The System

 **NOTE:** It is recommended that you always use a static mat and static strap while working on components in the interior of the system.

1. Turn off the system, including any attached peripherals, and disconnect the system from the electrical outlet and peripherals.
2. If applicable, rotate the system feet inward and lay the system on its side on a flat, stable surface.

 **NOTE:** For systems installed with the wheel assembly, ensure that you lay the system on a sturdy surface with the wheel assembly extending off the edge of the surface.

3. Using a screwdriver, rotate the latch release lock on the system cover counter clockwise to the unlocked position.
4. Press the cover release latch and lift the cover away from the system.

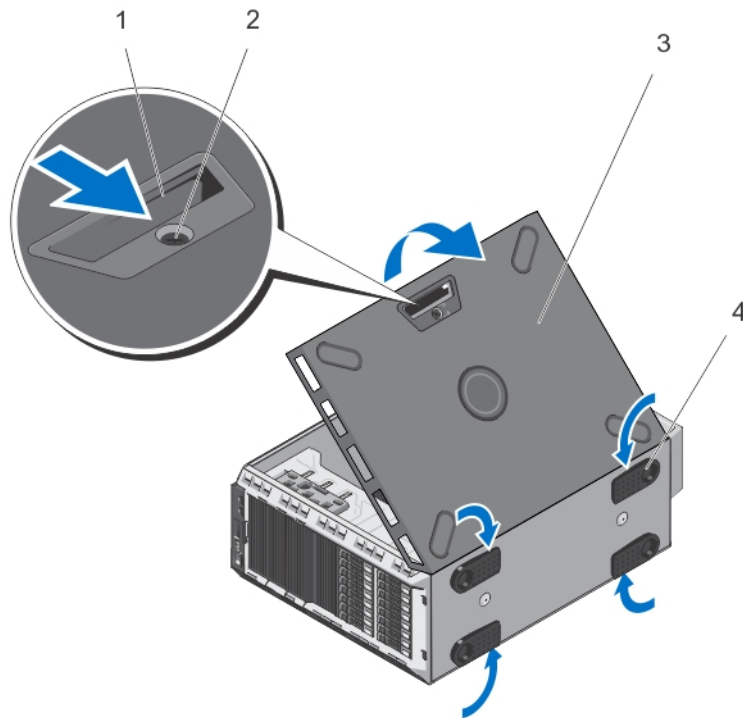

Figure 14. Opening and Closing the System

1. cover release latch
2. latch release lock
3. system cover
4. system feet (4)

Closing The System

1. Ensure that all internal cables are connected and placed out of the way and that no tools or extra parts are left inside the system.
2. Place the bottom edge of the system cover into the corresponding slots of the system chassis.
3. Lower the system cover onto the chassis.
4. Press the latch end of the system cover into the chassis until the latch locks into place.
5. Turn the latch release lock clockwise to the locked position.
6. If applicable, place the system upright on a flat, stable surface and rotate the system feet outward.
7. Reconnect the system to its electrical outlet and turn the system on, including any attached peripherals.

Inside The System

⚠ CAUTION: Many repairs may only be done by a certified service technician. You should only perform troubleshooting and simple repairs as authorized in your product documentation, or as directed by the online or telephone service and support team. Damage due to servicing that is not authorized by Dell is not covered by your warranty. Read and follow the safety instructions that came with the product.

 **NOTE:** Components that are hot-swappable are marked orange and touch-points on the components are marked blue.

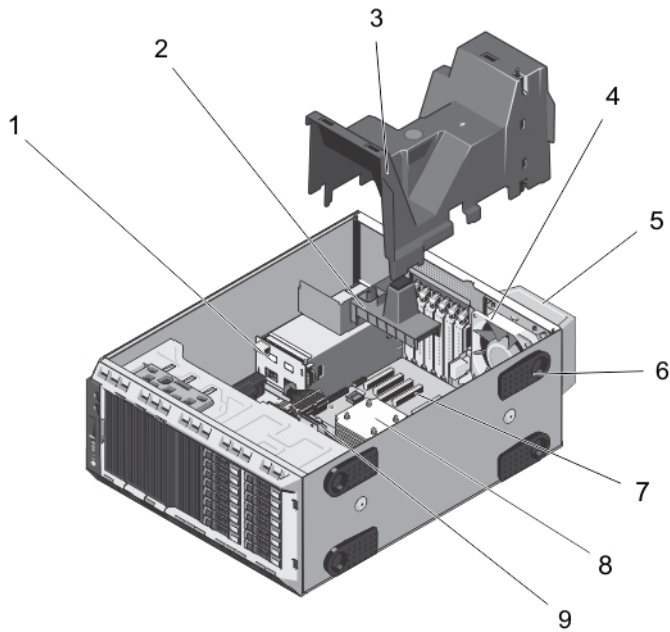

Figure 15. Inside the System—Hot-Swappable Hard Drives

- | | | | |
|----|---------------------------------|----|--------------------------|
| 1. | power interposer board | 6. | system feet (4) |
| 2. | PCIe card holder (optional) | 7. | expansion card slots (5) |
| 3. | cooling shroud | 8. | processor heat sink |
| 4. | internal cooling fan | 9. | hard-drive backplane |
| 5. | external cooling fan (optional) | | |

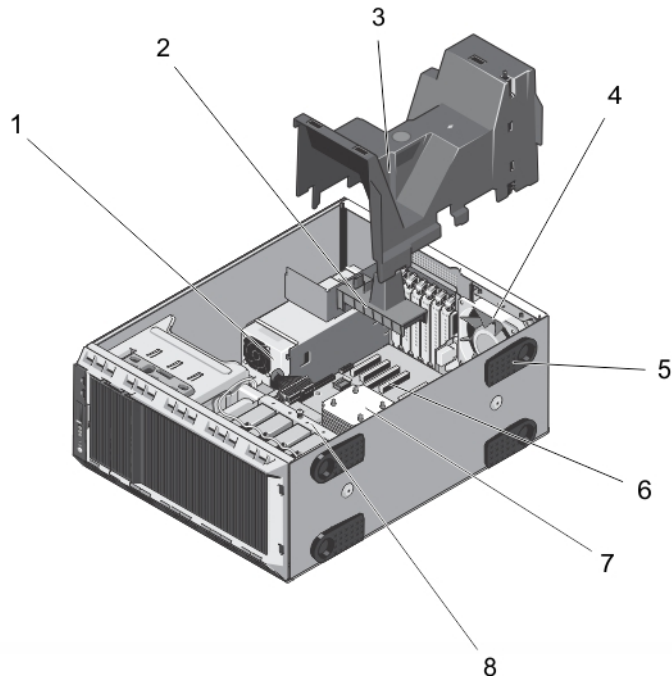



Figure 16. Inside the System—Cabled Hard Drives

- | | |
|--------------------------------|-----------------------------|
| 1. cabled power supply | 6. expansion card slots (5) |
| 2. PCIe card holder (optional) | 7. processor heat sink |
| 3. cooling shroud | 8. internal hard-drive bay |
| 4. internal cooling fan | |
| 5. system feet (4) | |

Optical Drives And Tape Drives (Optional)

Your system supports one of the following configurations:

- Systems with cabled hard drives support one optical drive and one tape drive.
- Systems with hot-swappable hard drives support up to two optical drives and one tape drive.

 **NOTE:** If your system is installed with a double-width GPU card, the system supports only one 5.25 inch removal media storage.

 **NOTE:** An optical drive may be replaced by a Dell PowerVault RD1000 removable media device.

For systems with hot-swappable hard drives, the optical and tape drives can be configured as follows:

Slot 1	SATA optical drive or PowerVault RD1000
Slot 2	SATA optical drive or PowerVault RD1000 or blank
Slot 3	SAS tape drive or blank

Removing The Optical Drive Or Tape Drive

 **CAUTION:** Many repairs may only be done by a certified service technician. You should only perform troubleshooting and simple repairs as authorized in your product documentation, or as directed by the online or telephone service and support team. Damage due to servicing that is not authorized by Dell is not covered by your warranty. Read and follow the safety instructions that came with the product.

1. If installed, remove the front bezel.
2. Turn off the system, including any attached peripherals, and disconnect the system from the electrical outlet and peripherals.

 **NOTE:** For systems installed with the wheel assembly, ensure that you lay the system on a sturdy, stable surface with the wheel assembly extending off the edge of the surface.

3. Open the system.
4. Disconnect the power and data cable from the back of the drive.
Note the routing of the power and data cable inside the chassis as you remove them from the system board and the drive. You must route these cables properly when you replace them to prevent them from being pinched or crimped.
5. To remove the drive, push the release latch towards the bottom of the system.
6. Slide the drive out of the system until it is free of the drive bay.

 **NOTE:** If the drive is being permanently removed, install a blank in the slot.

 **NOTE:** Filler brackets must be installed over empty optical drive or tape drive slots to maintain FCC certification of the system. The brackets also keep dust and dirt out of the system and aid in proper cooling and airflow inside the system.

7. Close the system.
8. If applicable, install the front bezel.
9. If applicable, place the system upright on a flat, stable surface and rotate the system feet outward.
10. Reconnect the system to its electrical outlet and turn the system on, including any attached peripherals.

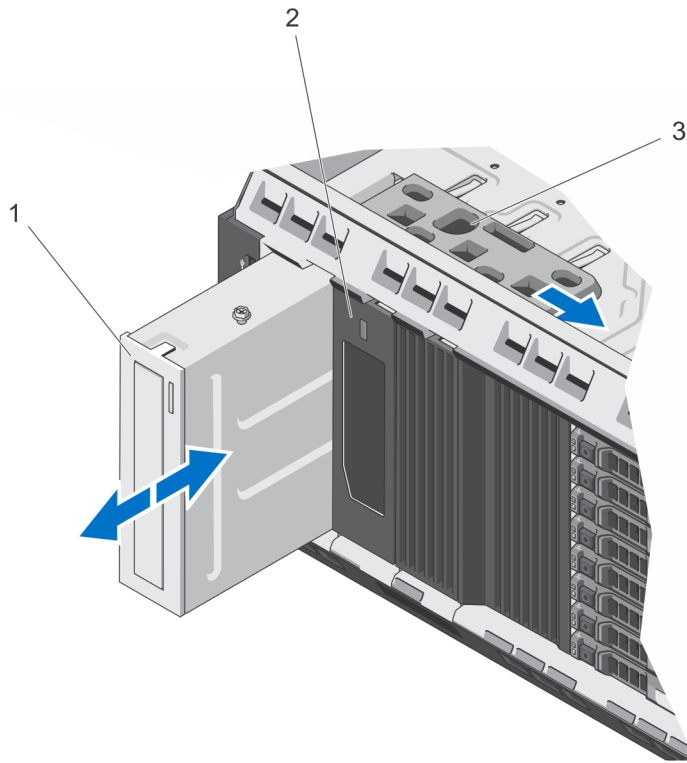

Figure 17. Removing and Installing the Optical Drive or Tape Drive

1. optical drive
2. tape drive
3. release latch

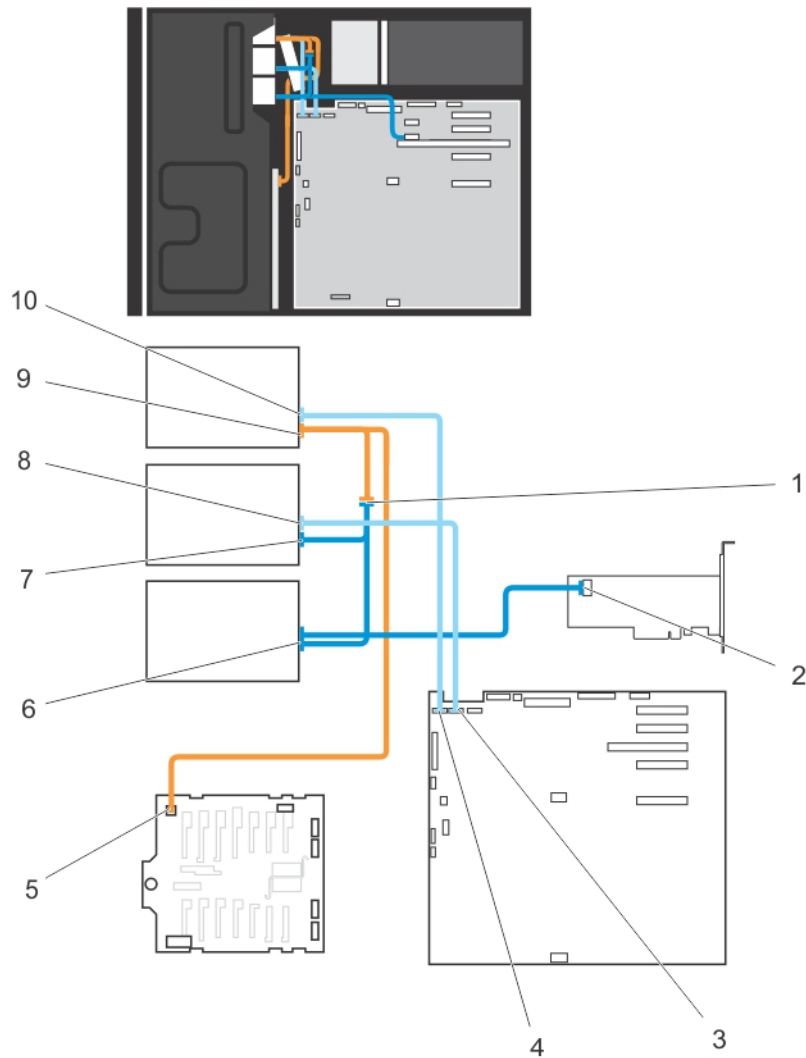



Figure 18. Cabling—Optical Drive and Tape Drive

- | | |
|--|-----------------------------------|
| 1. connector for power cable extension | 7. optical drive2 power connector |
| 2. mini-SAS connector on PERC card | 8. optical drive2 data connector |
| 3. ODD2/TBU connector on system board | 9. optical drive1 power connector |
| 4. ODD1/TBU connector on system board | 10. optical drive1 data connector |
| 5. power connector on x8 backplane | |
| 6. SAS tape drive data/power connector | |

Installing The Optical Drive Or Tape Drive

 **CAUTION:** Many repairs may only be done by a certified service technician. You should only perform troubleshooting and simple repairs as authorized in your product documentation, or as directed by the online or telephone service and support team. Damage due to servicing that is not authorized by Dell is not covered by your warranty. Read and follow the safety instructions that came with the product.

1. Unpack and prepare the drive for installation.
For instructions, see the documentation that accompanied the drive.
If you are installing a SAS tape drive, you must have an internal SAS expansion card installed. See Installing An Expansion Card.
2. If installed, remove the front bezel.
3. Turn off the system, including any attached peripherals, and disconnect the system from the electrical outlet and peripherals.
4. If applicable, rotate the system feet inward and lay the system on its side on a flat and stable surface.

 **NOTE:** For systems installed with the wheel assembly, ensure that you lay the system on a sturdy, stable surface with the wheel assembly extending off the edge of the surface.

5. Open the system.
6. If applicable, remove the old drive or the drive blank.
7. Align the drive with the drive bay.
8. Slide the drive into the slot until the latch snaps into place.
9. Connect the power and data cable to the back of the drive.
10. Connect the power and data cables to the backplane and the system board.
The system board connectors are ODD1/TBU and ODD2/TBU. The system can connect up to two optical drives, or one optical drive with one SATA tape backup unit, and one SAS tape backup unit using Dell OpenManage IT Assistant.

 **NOTE:** For systems configured with software RAID and installed with PowerVault RD1000, connect the PowerVault RD1000 data cable to ODD1/TBU (SATA_E) port and the optical drive data cable to ODD2/TBU (SATA_F) port on the system board respectively.

11. Close the system.
12. If applicable, place the system upright on a flat, stable surface and rotate the system feet outward.
13. Reconnect the system to its electrical outlet and turn the system on, including any attached peripherals.
14. If applicable, install the front bezel.

Cooling Shroud

Removing The Cooling Shroud

 **CAUTION:** Many repairs may only be done by a certified service technician. You should only perform troubleshooting and simple repairs as authorized in your product documentation, or as directed by the online or telephone service and support team. Damage due to servicing that is not authorized by Dell is not covered by your warranty. Read and follow the safety instructions that came with the product.

CAUTION: Never operate your system with the cooling shroud removed. The system may get overheated quickly, resulting in shutdown of the system and loss of data.

1. Turn off the system, including any attached peripherals, and disconnect the system from the electrical outlet and peripherals.
2. If applicable, rotate the system feet inward and lay the system on its side on a flat, stable surface.

NOTE: For systems installed with the wheel assembly, ensure that you lay the system on a sturdy, stable surface with the wheel assembly extending off the edge of the surface.

3. Open the system.
4. Lift the cooling shroud away from the system.

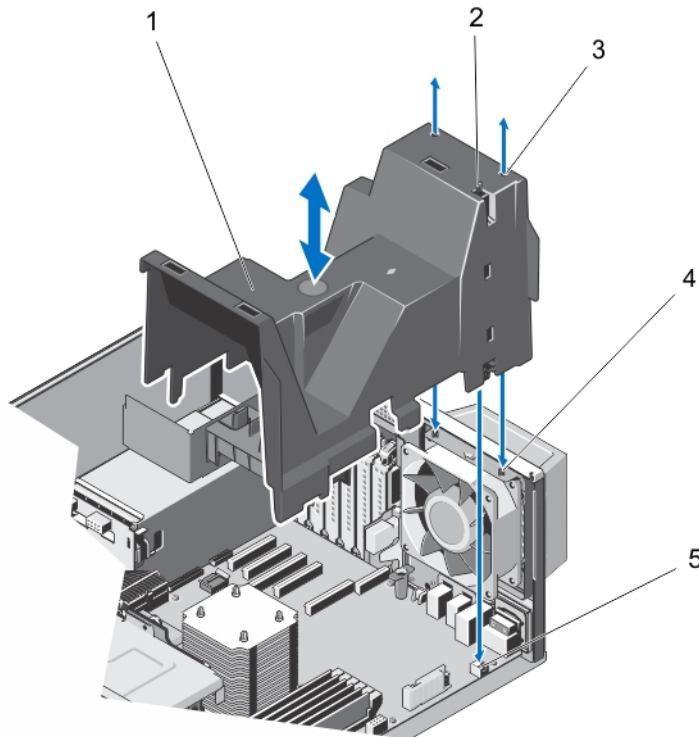



Figure 19. Removing and Installing the Cooling Shroud

- | | |
|---------------------------------------|---|
| 1. cooling shroud | 5. chassis intrusion-switch connector on the system board |
| 2. chassis intrusion-switch | |
| 3. slots (2) | |
| 4. tabs on the system cooling fan (2) | |

Installing The Cooling Shroud

CAUTION: Many repairs may only be done by a certified service technician. You should only perform troubleshooting and simple repairs as authorized in your product documentation, or as directed by the online or telephone service and support team. Damage due to servicing that is not authorized by Dell is not covered by your warranty. Read and follow the safety instructions that came with the product.

 **CAUTION: Do not operate the system with the cover removed for a duration exceeding 5 minutes.**

 **NOTE:** For proper seating of the cooling shroud in the system chassis, ensure that the cables inside the system are routed along the chassis wall and secured using the cable securing clips.

1. Align the two slots on the cooling shroud with the tabs on the internal cooling fan.
2. Lower the cooling shroud into the chassis until the two slots on the cooling shroud are flush with the tabs on the internal cooling fan.

 **NOTE:** When the cooling shroud is properly seated, the chassis intrusion-switch on the cooling shroud connects to the chassis intrusion-switch connector on the system board.

3. Close the system.
4. If applicable, place the system upright on a flat, stable surface and rotate the system feet outward.
5. Reconnect the system to its electrical outlet and turn the system on, including any attached peripherals.

Hard Drives—Hot-Swappable

Your system supports one of the following configurations:

- Up to eight 3.5 inch (SAS, SATA, or SSD) hot-swappable hard drives
- Up to eight 2.5 inch (SAS, SATA, or SSD) hot-swappable hard drives installed in 3.5 inch hard-drive adapters, which are then installed in the 3.5 inch hard-drive carriers
- Up to sixteen 2.5 inch (SAS, SATA, or SSD) hot-swappable hard drives

 **CAUTION: Before attempting to remove or install a hot-swappable hard drive while the system is running, see the documentation for the storage controller card to ensure that the host adapter is configured correctly to support hot-swap hard drive removal and insertion.**

 **CAUTION: Do not turn off or reboot your system while the hard drive is being formatted. Doing so can cause a hard drive failure. Be aware that high-capacity hard drives can take a number of hours to format.**

 **NOTE:** All hot-swappable hard drives connect to the system board through the hard-drive backplane. Hard drives are supplied in hot-swappable hard-drive carriers that fit in the hard-drive slots.

 **NOTE:** Use only hot-swappable hard drives that have been tested and approved for use with the hard-drive backplane.

Removing A Hot-Swap Hard Drive

 **CAUTION: To prevent data loss, ensure that your operating system supports hot-swap drive installation. See the documentation supplied with your operating system.**

1. From the management software, prepare the hard drive for removal. Wait until the indicators on the hard-drive carrier signal that the hard drive can be removed safely. For more information, see the documentation for the storage controller.

If the hard drive is online, the green activity/fault indicator flashes as the drive is turned off. When the hard-drive indicators are off, the hard drive is ready for removal.

2. Press the release button to open the hard-drive carrier release handle.
3. Slide the hard-drive carrier out until it is free of the hard-drive slot.

 **CAUTION: To maintain proper system cooling, all empty hard-drive slots must have hard-drive blanks installed.**

4. Insert a hard-drive blank in the empty hard-drive slot.

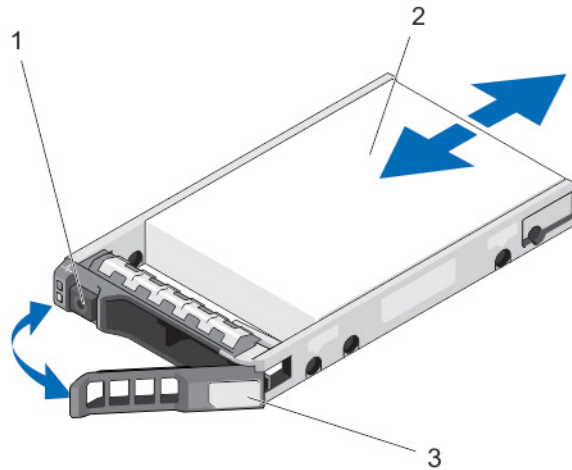

Figure 20. Removing and Installing a Hot-Swap Hard Drive

1. release button
2. hard drive
3. hard-drive carrier handle

Installing A Hot-Swap Hard Drive

- △ **CAUTION:** Many repairs may only be done by a certified service technician. You should only perform troubleshooting and simple repairs as authorized in your product documentation, or as directed by the online or telephone service and support team. Damage due to servicing that is not authorized by Dell is not covered by your warranty. Read and follow the safety instructions that came with the product.
- △ **CAUTION:** Use only hard drives that have been tested and approved for use with the hard-drive backplane.
- △ **CAUTION:** Combining SAS and SATA hard drives in the same RAID volume is not supported.
- △ **CAUTION:** When installing a hard drive, ensure that the adjacent drives are fully installed. Inserting a hard-drive carrier and attempting to lock its handle next to a partially installed carrier can damage the partially installed carrier's shield spring and make it unusable.
- △ **CAUTION:** To prevent data loss, ensure that your operating system supports hot-swap drive installation. See the documentation supplied with your operating system.
- △ **CAUTION:** When a replacement hot-swappable hard drive is installed and the system is powered on, the hard drive automatically begins to rebuild. Make absolutely sure that the replacement hard drive is blank or contains data that you wish to have over-written. Any data on the replacement hard drive is immediately lost after the hard drive is installed.

1. If a hard-drive blank is installed in the hard-drive slot, remove it.
2. Install a hard drive in the hard-drive carrier.
3. Press the release button on the front of the hard-drive carrier and open the hard-drive carrier handle.
4. Insert the hard-drive carrier into the hard-drive slot until the carrier connects with the backplane.
5. Close the hard-drive carrier handle to lock the hard drive in place.

Removing A 2.5 Inch Hard-Drive Blank

△ CAUTION: To maintain proper system cooling, all empty hard-drive slots must have hard-drive blanks installed.

1. If installed, remove the front bezel.
2. Press the release button and slide the hard-drive blank out until it is free of the hard-drive slot.

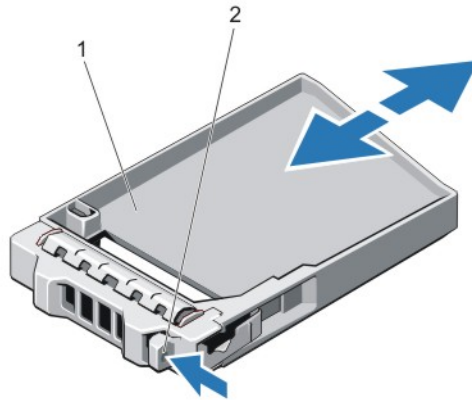

Figure 21. Removing and Installing a 2.5 Inch Hard-Drive Blank

1. hard-drive blank
2. release button

Installing A 2.5 Inch Hard-Drive Blank

1. If installed, remove the front bezel.
2. Insert the hard-drive blank into the hard-drive slot until the release button clicks into place.
3. If applicable, install the front bezel.

Removing A 3.5 Inch Hard-Drive Blank

△ CAUTION: To maintain proper system cooling, all empty hard-drive slots must have drive blanks installed.

1. If installed, remove the front bezel.
2. Grasp the front of the hard-drive blank, press the release button and slide the blank out until it is free of the hard-drive slot.

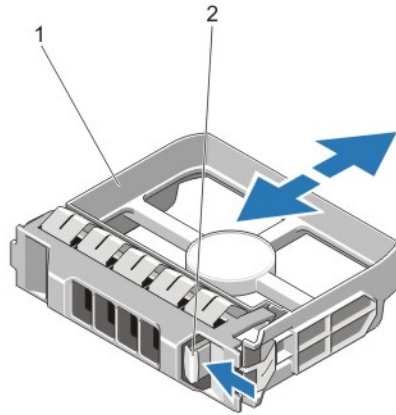



Figure 22. Removing and Installing a 3.5 Inch Hard-Drive Blank

1. hard-drive blank
2. release button

Installing A 3.5 Inch Hard-Drive Blank

1. If installed, remove the front bezel.
2. Insert the hard-drive blank into the hard-drive slot until the release button clicks into place.
3. If applicable, install the front bezel.

Removing A 2.5 Inch Hard Drive From A 3.5 Inch Hard-Drive Adapter

 **NOTE:** A 2.5 inch hard drive is installed into a 3.5 inch hard-drive adapter, which is then installed in the 3.5 inch hard-drive carrier

1. Remove the two screws from the side of the 3.5 inch hard-drive adapter.
2. Remove the hard-drive away from the hard-drive adapter.

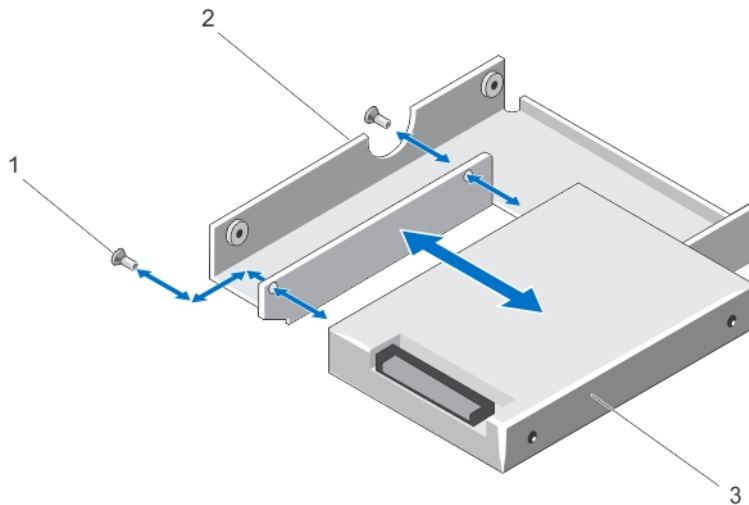

Figure 23. Removing and Installing a 2.5 Inch Hard Drive Into a 3.5 Inch Hard-Drive Adapter

1. screws (2)
2. 3.5 inch hard-drive adapter
3. 2.5 inch hard drive

Installing A 2.5 Inch Hard Drive Into A 3.5 Inch Hard-Drive Adapter

CAUTION: Many repairs may only be done by a certified service technician. You should only perform troubleshooting and simple repairs as authorized in your product documentation, or as directed by the online or telephone service and support team. Damage due to servicing that is not authorized by Dell is not covered by your warranty. Read and follow the safety instructions that came with the product.

1. Align the screw holes on the 2.5 inch hard drive with the screw holes on the 3.5 inch hard-drive adapter.
2. Install the screws to secure the hard drive to the hard-drive adapter.

Removing A Hard Drive Or A Hard-Drive Adapter From A Hard-Drive Carrier

1. Remove the screws from the slide rails on the hard-drive carrier.
2. Lift the hard-drive adapter out of the hard-drive carrier.

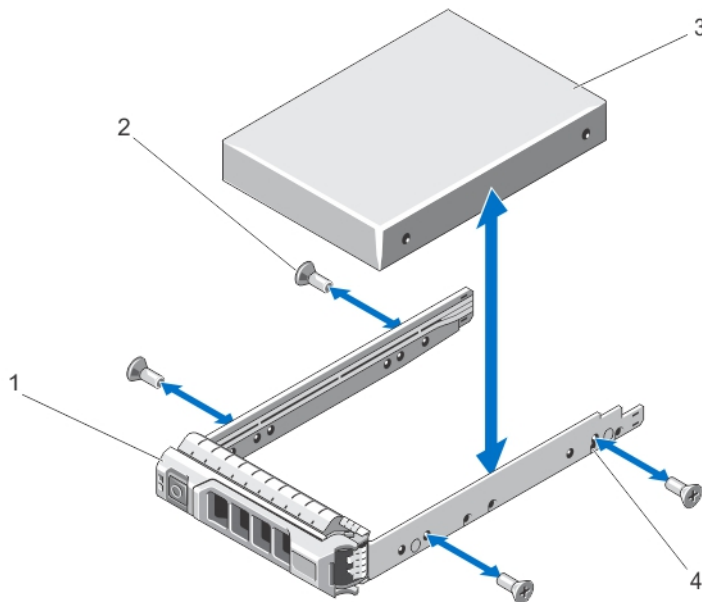

Figure 24. Removing and Installing a Hot-Swap Hard Drive Into a Hard-Drive Carrier

1. hard-drive carrier
2. screws (4)
3. hard drive
4. screw holes (4)

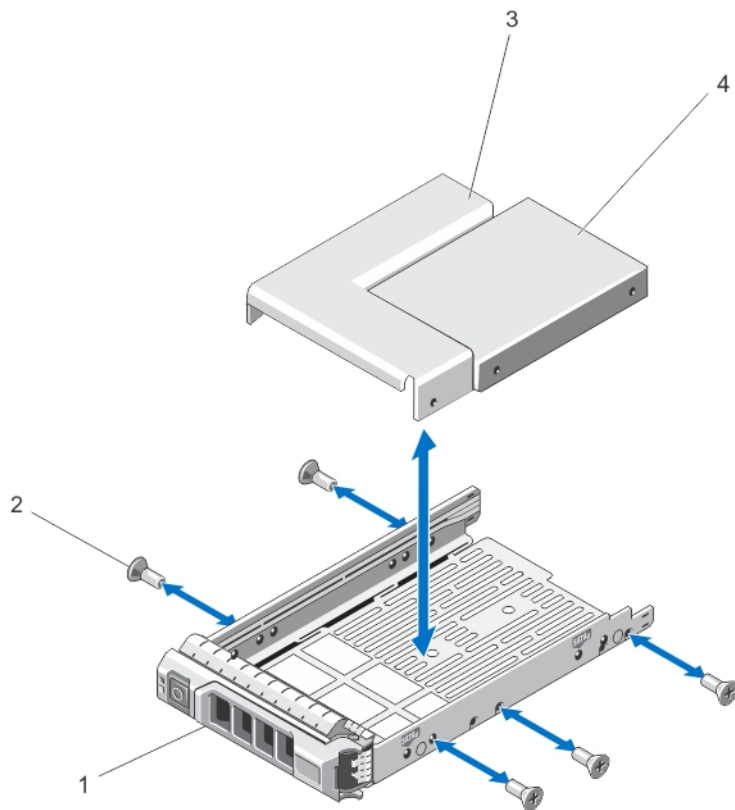

Figure 25. Removing and Installing a Hard-Drive Adapter Into a 3.5 Inch Hard-Drive Carrier

1. hard-drive carrier
2. screws (5)
3. hard-drive adapter
4. 2.5 inch hard drive

Installing A Hard Drive Or A Hard-Drive Adapter Into A Hard-Drive Carrier

CAUTION: Many repairs may only be done by a certified service technician. You should only perform troubleshooting and simple repairs as authorized in your product documentation, or as directed by the online or telephone service and support team. Damage due to servicing that is not authorized by Dell is not covered by your warranty. Read and follow the safety instructions that came with the product.

1. Insert the hard-drive adapter into the hard-drive carrier with the connector end of the hard drive toward the back.
2. Align the screw holes on the hard drive with the back set of holes on the hard-drive carrier. When aligned correctly, the back of the hard drive is flush with the back of the hard-drive carrier.
3. Attach the screws to secure the hard drive to the hard-drive carrier.

Hard Drives—Cabled

Your system supports up to four 3.5 inch (SAS or SATA) cabled hard drives. Cabled hard drives are installed in an internal hard-drive bay.

CAUTION: Do not turn off or reboot your system while the hard drive is being formatted. Doing so can cause a hard drive failure.

NOTE: Use only hard drives that have been tested and approved for use with your system.

Removing The Internal Hard-Drive Bay

CAUTION: Many repairs may only be done by a certified service technician. You should only perform troubleshooting and simple repairs as authorized in your product documentation, or as directed by the online or telephone service and support team. Damage due to servicing that is not authorized by Dell is not covered by your warranty. Read and follow the safety instructions that came with the product.

1. Turn off the system, including any attached peripherals, and disconnect the system from the electrical outlet and peripherals.
2. If applicable, rotate the system feet inward and lay the system on its side on a flat, stable surface.

NOTE: For systems installed with the wheel assembly, ensure that you lay the system on a sturdy, stable surface with the wheel assembly extending off the edge of the surface.

3. Open the system.
4. Disconnect the data and power cable(s) from the hard drive(s).
5. Loosen the two captive screws securing the internal hard-drive bay to the chassis.
6. Lift the internal hard-drive bay up and out of the chassis.

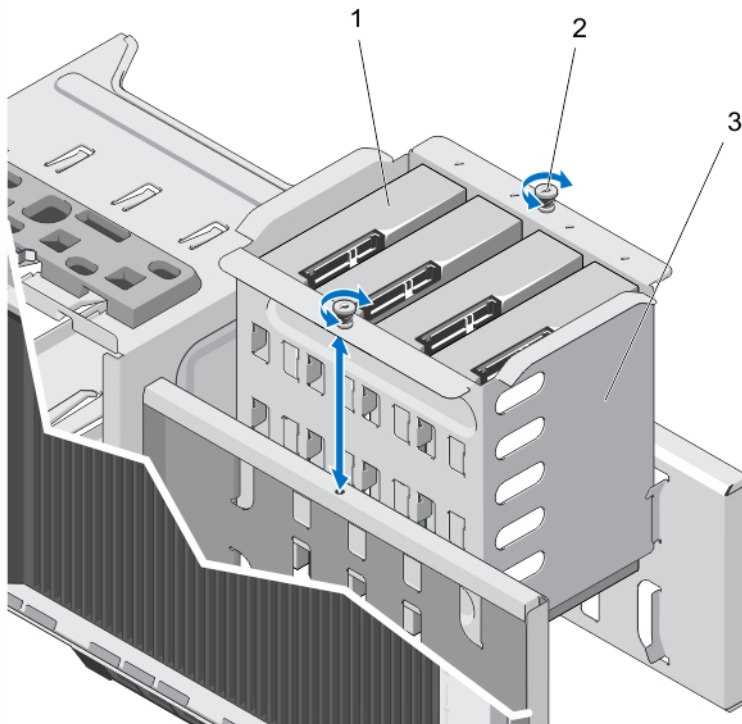



Figure 26. Installing and Removing the Internal Hard-Drive Bay

1. cabled hard drives (4)
2. captive screws (2)

3. internal hard-drive bay

Installing The Internal Hard-Drive Bay

 **CAUTION:** Many repairs may only be done by a certified service technician. You should only perform troubleshooting and simple repairs as authorized in your product documentation, or as directed by the online or telephone service and support team. Damage due to servicing that is not authorized by Dell is not covered by your warranty. Read and follow the safety instructions that came with the product.

1. Align the internal hard-drive bay with the tabs on the chassis and slide the internal hard-drive bay into the chassis.
2. Secure the internal hard-drive bay to the chassis using the two captive screws.
3. Connect the data and power cable(s) to the hard drive(s).
4. Close the system.
5. Place the system upright on a flat, stable surface and if applicable, rotate the system feet outward.
6. Reconnect the system to its electrical outlet and turn the system on, including any attached peripherals.

Removing A Cabled Hard Drive

 **CAUTION:** Many repairs may only be done by a certified service technician. You should only perform troubleshooting and simple repairs as authorized in your product documentation, or as directed by the online or telephone service and support team. Damage due to servicing that is not authorized by Dell is not covered by your warranty. Read and follow the safety instructions that came with the product.

1. Turn off the system, including any attached peripherals, and disconnect the system from the electrical outlet and peripherals.
2. If applicable, rotate the system feet inward and lay the system on its side on a flat, stable surface.

 **NOTE:** For systems installed with the wheel assembly, ensure that you lay the system on a sturdy, stable surface with the wheel assembly extending off the edge of the surface.

3. Open the system.
4. Remove the power and data cable(s) from the hard drive(s) in the internal hard-drive bay.
5. Remove the internal hard-drive bay.
6. Remove the four screws securing the hard drive to the internal hard-drive bay.
7. Remove the hard drive from the internal hard-drive bay.
8. Install the internal hard-drive bay into the chassis.
9. If applicable, connect the power and data cable(s) to the remaining hard drive(s) in the internal hard-drive bay.

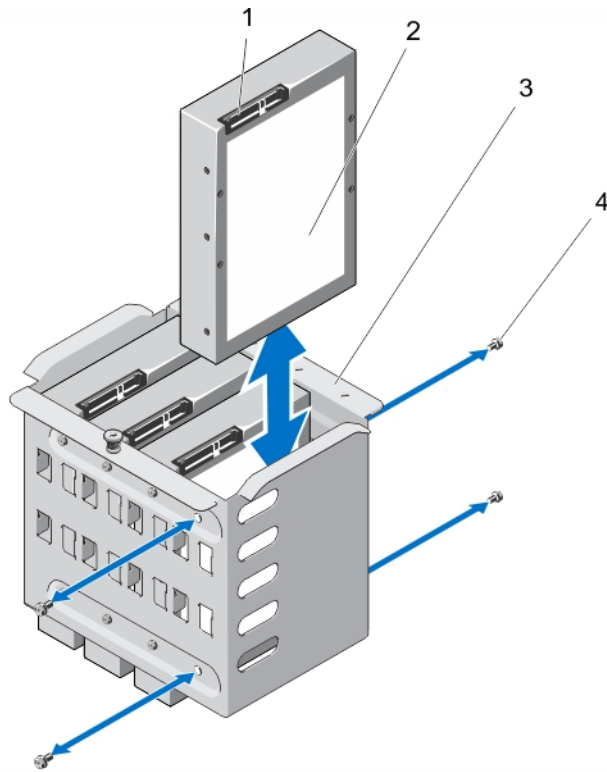

Figure 27. Removing and Installing a Cabled Hard Drive

1. hard drive connector
2. hard drive
3. internal hard-drive bay
4. screws (4)

Installing A Cabled Hard Drive

⚠ CAUTION: Many repairs may only be done by a certified service technician. You should only perform troubleshooting and simple repairs as authorized in your product documentation, or as directed by the online or telephone service and support team. Damage due to servicing that is not authorized by Dell is not covered by your warranty. Read and follow the safety instructions that came with the product.

1. Turn off the system, including any attached peripherals, and disconnect the system from the electrical outlet and peripherals.
2. If applicable, rotate the system feet inward and lay the system on its side on a flat, stable surface.
 - 🔧 NOTE:** For systems installed with the wheel assembly, ensure that you lay the system on a sturdy, stable surface with the wheel assembly extending off the edge of the surface.
3. Open the system.
4. Disconnect the power and data cable(s) from the hard drive(s) in the internal hard-drive bay.
5. Remove the internal hard-drive bay.
6. Insert the hard drive into the internal hard-drive bay with the hard-drive connector facing outward.
7. Secure the hard drive to the internal hard-drive bay with the four screws.

8. Install the internal hard-drive bay into the chassis.
9. Connect the power and data cable(s) to the hard drive(s).
10. Close the system.
11. Place the system upright on a flat, stable surface and if applicable, rotate the system feet outward.
12. Reconnect the system to its electrical outlet and turn the system on, including any attached peripherals.
13. Enter the System Setup and ensure that the hard drive's controller is enabled.
14. Exit the System Setup program and reboot the system.
15. Install any software required for the hard drive operation as described in the documentation for the hard drive.

Hard-Drive Backplane

Your system supports one of the following configurations:

- x8 SAS/SATA backplane for 3.5 inch hard drives
 -  **NOTE:** The x8 backplane also supports up to eight 2.5 inch (SAS, SATA, or SSD) hot-swappable hard drives installed in 3.5 inch hard-drive adapters, which are then installed in the 3.5 inch hard-drive carriers.
- x16 SAS/SATA backplane for 2.5 inch hard drives

 **NOTE:** Your system backplane can also support SAS/SATA SSDs.

 **NOTE:** Hard-drive backplanes are supported in systems with hot-swappable hard drives only.

Removing The Hard-Drive Backplane

 **CAUTION:** Many repairs may only be done by a certified service technician. You should only perform troubleshooting and simple repairs as authorized in your product documentation, or as directed by the online or telephone service and support team. Damage due to servicing that is not authorized by Dell is not covered by your warranty. Read and follow the safety instructions that came with the product.

1. If installed, remove the front bezel.
2. Turn off the system, including any attached peripherals, and disconnect the system from the electrical outlet and peripherals.

 **CAUTION:** To prevent damage to the drives and backplane, you must remove the hard drives from the system before removing the backplane.

 **CAUTION:** You must note the slot number of each hard drive and temporarily label them before removal so that you can replace them in the same locations.

3. Remove all hard drives.
4. If applicable, rotate the system feet inward and lay the system on its side on a flat, stable surface.

 **NOTE:** For systems installed with the wheel assembly, ensure that you lay the system on a sturdy, stable surface with the wheel assembly extending off the edge of the surface.

5. Open the system.
6. Disconnect the SAS, power, signal, and I2C cables from the hard-drive backplane.

 **NOTE:** For the x8 backplane, press the SAS connector and push the connector toward the top of the system to release the SAS cable from the backplane.

7. Pull the release pin and lift the backplane out of the system.

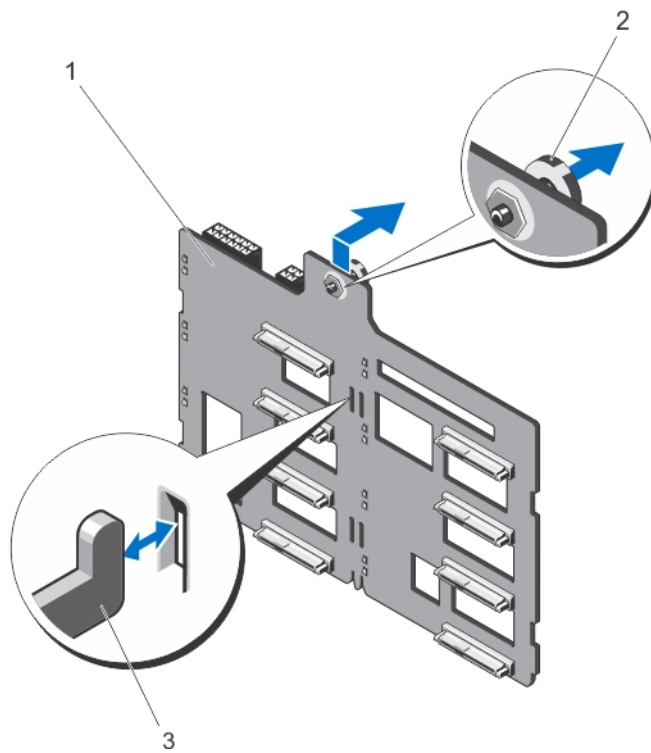

Figure 28. Removing and Installing an x8 Hard-Drive Backplane

1. x8 hard-drive backplane
2. release pin
3. hooks (11)

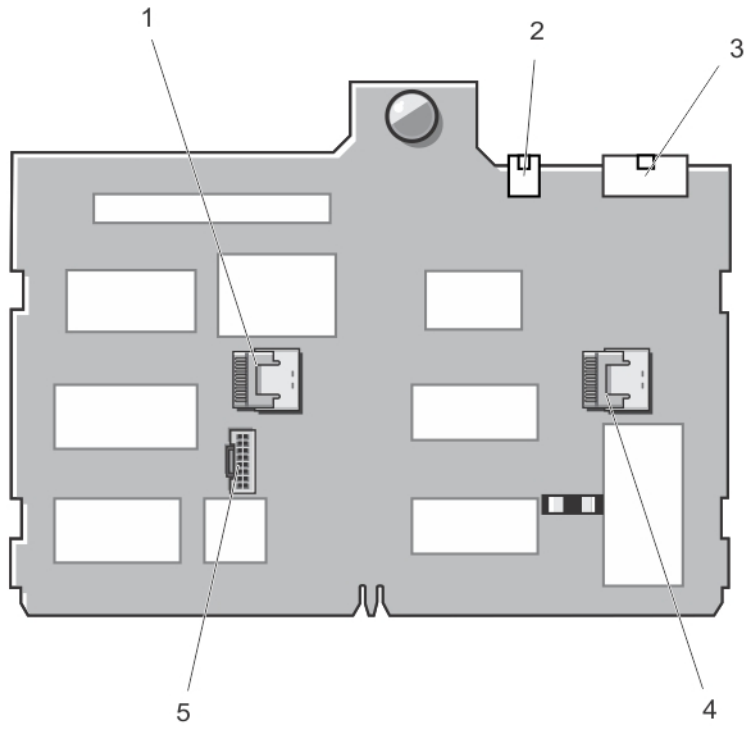

Figure 29. Connectors on an x8 Hard-Drive Backplane

- | | |
|---|--------------------|
| 1. SAS B connector | 4. SAS A connector |
| 2. power connector for optical drive and tape drive | 5. I2C connector |
| 3. backplane power connector | |

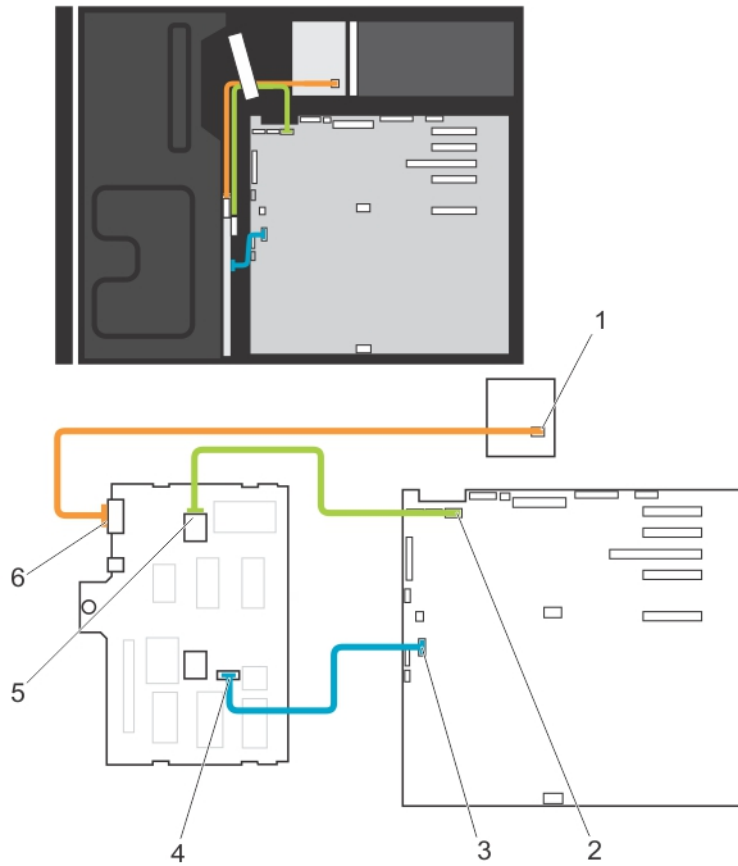

Figure 30. Cabling—x8 Hard-Drive Backplane

- | | |
|------------------------------------|---------------------------------|
| 1. power connector | 5. SAS A connector on backplane |
| 2. SAS A connector on system board | 6. backplane power connector |
| 3. I2C connector on system board | |
| 4. I2C connector on backplane | |

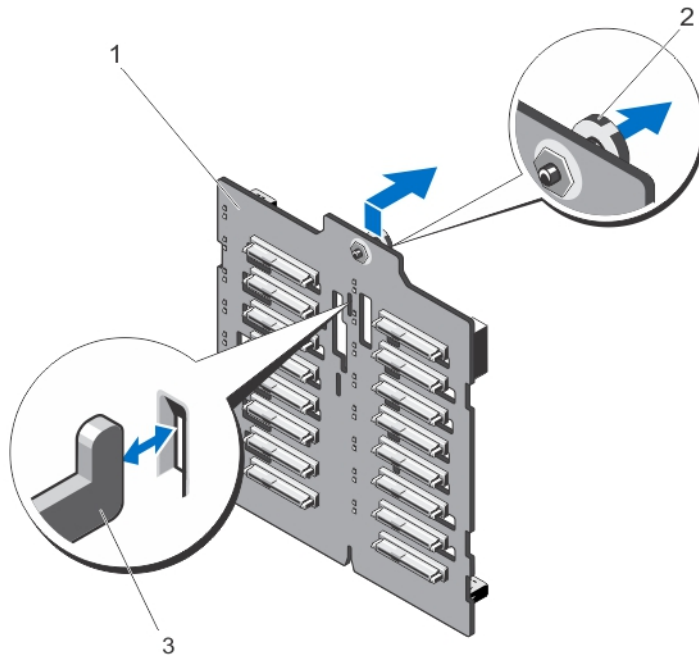

Figure 31. Removing and Installing an x16 Hard-Drive Backplane

1. x16 hard-drive backplane
2. release pin
3. hooks (7)

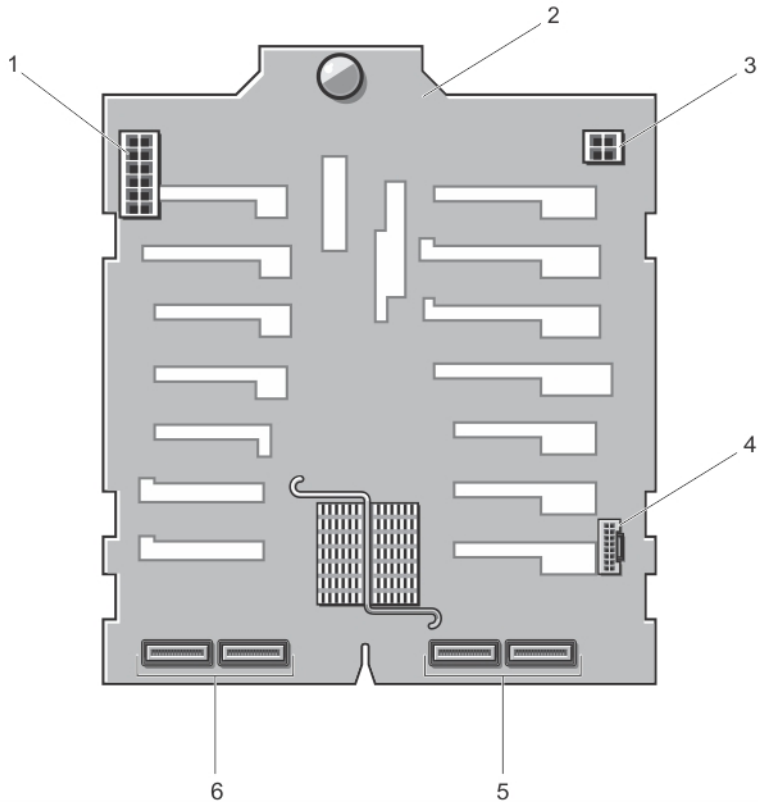

Figure 32. Connectors on an x16 Hard-Drive Backplane

- | | |
|---|---|
| 1. backplane power connector | 5. primary SAS connectors (A and B) |
| 2. backplane | 6. secondary SAS connectors (A1 and B1) |
| 3. power connector for optical drive and tape drive | |
| 4. I2C connector | |

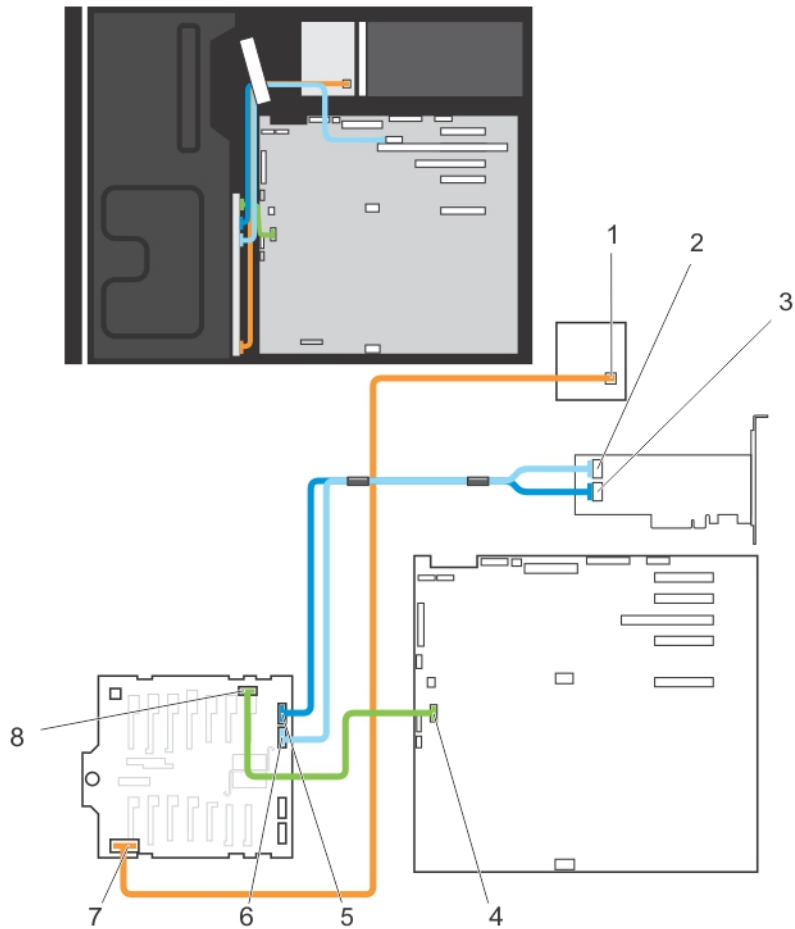

Figure 33. Cabling—x16 Hard-Drive Backplane With Expansion Card

- | | |
|---|---------------------------------|
| 1. power connector on power distribution board | 6. SAS B connector on backplane |
| 2. SAS B connector on PowerEdge RAID Controller (PERC) card | 7. backplane power connector |
| 3. SAS A connector on PERC card | 8. I2C connector on backplane |
| 4. I2C connector on system board | |
| 5. SAS A connector on backplane | |

Installing The Hard-Drive Backplane

CAUTION: Many repairs may only be done by a certified service technician. You should only perform troubleshooting and simple repairs as authorized in your product documentation, or as directed by the online or telephone service and support team. Damage due to servicing that is not authorized by Dell is not covered by your warranty. Read and follow the safety instructions that came with the product.

1. Use the hooks at the back of the hard-drive bay as guides to align the hard-drive backplane.
2. Slide down the hard-drive backplane until the release pin locks into the slot.
3. Connect the SAS, power, signal, and I2C cables to the hard-drive backplane.
4. Install the hard drives in their original locations.

5. Close the system.
6. If applicable, place the system upright on a flat, stable surface and rotate the system feet outward.
7. Reconnect the system to its electrical outlet and turn the system on, including any attached peripherals.
8. If applicable, install the front bezel.

Four-Slot Hard-Drive Blank

Systems with x8 hard-drive backplanes configured for software RAID support only four hard drives. The remaining hard-drive slots are pre-installed with the four-slot hard-drive blank, and are not available for software RAID.

Removing A Four-Slot Hard-Drive Blank

 **CAUTION:** To maintain proper system cooling, all empty hard-drive slots must have hard-drive blanks installed.

 **NOTE:** This is a service only procedure.

1. If installed, remove the front bezel.
2. Turn off the system, including any attached peripherals, and disconnect the system from the electrical outlet and peripherals.

 **CAUTION:** To prevent damage to the hard drives and backplane, you must remove the hard drives from the system before removing the backplane.

 **CAUTION:** You must note the slot number of each hard drive and temporarily label them before removal so that you can replace them in the same location(s).

3. Remove all hard drives.
4. If applicable, rotate the system feet inward and lay the system on its side on a flat, stable surface.

 **NOTE:** For systems installed with the wheel assembly, ensure that you lay the system on a sturdy surface with the wheel assembly extending off the edge of the surface.

5. Open the system.
6. Remove the cooling shroud.
7. Remove the x8 hard-drive backplane.
8. Using a screwdriver, push the release tabs on the four corners of the blank from inside the system, to unlock the four-slot hard-drive blank from the chassis.
9. From the front of the system, pull the four-slot hard-drive blank at the corners until it is free of the hard-drive slot.

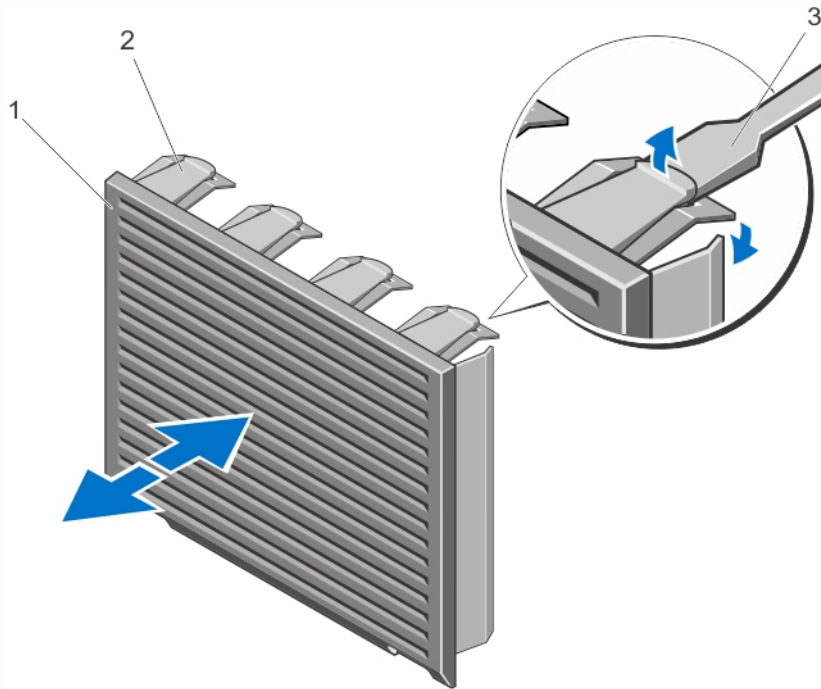

Figure 34. Installing and Removing the Four-Slot Hard-Drive Blank

1. four-slot hard-drive blank
2. release tab
3. screwdriver

Installing A Four-Slot Hard-Drive Blank

1. Locate the hard drive slots numbered from four to seven.
2. Insert the four-slot hard-drive blank into the hard-drive slot, and push it until the release tabs click into place.
3. Close the system.
4. If applicable, place the system upright on a flat, stable surface and rotate the system feet outward.
5. If applicable, install the front bezel.
6. Reconnect the system to its electrical outlet and turn the system on, including any attached peripherals.

System Memory

Your system supports DDR3 unbuffered ECC DIMMs (ECC UDIMMs), and registered DIMMs (RDIMMs). It supports DDR3 and DDR3L voltage specifications.

 **NOTE:** MT/s indicates DIMM speed in MegaTransfers per second.

Memory bus operating frequency can be 1600 MT/s, 1333 MT/s, 1066 MT/s, or 800 MT/s depending on:

- DIMM type (UDIMM or RDIMM)
- DIMM configuration (number of ranks)
- maximum frequency of the DIMMs

- number of DIMMs populated per channel
- DIMM operating voltage
- system profile selected (for example, **Performance Optimized**, **Custom**, or **Dense Configuration Optimized**)
- maximum supported DIMM frequency of the processor

The system contains six memory sockets organized into three channels. In each channel, the release levers of the first socket are marked white and the second socket black.

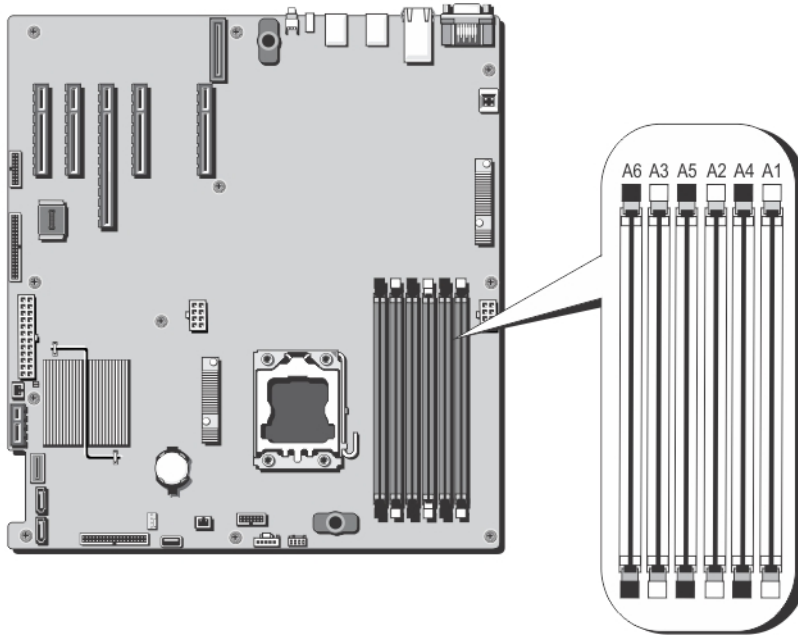

Figure 35. Memory Socket Locations

Memory channels are organized as follows:

- channel 1: memory sockets A1 and A4
- channel 2: memory sockets A2 and A5
- channel 3: memory sockets A3 and A6

The following table shows the memory populations and operating frequencies for the supported configurations.

DIMM Type	DIMMs Populated/ Channel	Operating Frequency (in MT/s)		Maximum DIMM Rank/ Channel
		1.5 V	1.35 V	
UDIMM ECC	1	1333, 1066, and 800	1333, 1066, and 800	Dual rank
	2	1333, 1066, and 800	1333, 1066, and 800	Dual rank

DIMM Type	DIMMs Populated/ Channel	Operating Frequency (in MT/s)		Maximum DIMM Rank/ Channel
		1.5 V	1.35 V	
RDIMM	1	1333, 1066, and 800	1333, 1066, and 800	Dual rank
		1333, 1066, and 800	1066 and 800	Quad rank
	2	1600, 1333, 1066, and 800	1333, 1066, and 800	Dual rank
		1066 and 800	1066 and 800	Quad rank

General Memory Module Installation Guidelines

 **NOTE:** Memory configurations that fail to observe these guidelines can prevent your system from booting, hanging during memory configuration, or operating with reduced memory.

This system supports **Flexible Memory Configuration**, enabling the system to be configured and run in any valid chipset architectural configuration. The following are the recommended guidelines for best performance:

- UDIMMs and RDIMMs must not be mixed.
- x4 and x8 DRAM based DIMMs can be mixed.
For more information, see Mode-Specific Guidelines.
- A maximum of two UDIMMs can be populated in a channel.
- A maximum of two single- or dual-rank RDIMMs can be populated in a channel.
- Populate all sockets with white release tabs first, and then black.
- Populate the sockets by highest rank count in the following order - first in sockets with white release levers, and then black.
For example, if you want to mix quad-rank and dual-rank DIMMs, populate quad-rank DIMMs in the sockets with white release tabs and dual-rank DIMMs in the sockets with black release tabs.
- Memory modules of different sizes can be mixed provided that other memory population rules are followed.
For example, 2 GB and 4 GB memory modules can be mixed.
- Depending on mode-specific guidelines, populate two or three DIMMs per processor (one DIMM per channel) at a time to maximize performance.
For more information, see Mode-Specific Guidelines.
- If memory modules with different speeds are installed, they will operate at the speed of the slowest installed memory module(s) or slower depending on system DIMM configuration.

Mode-Specific Guidelines

The allowable configurations depend on the memory mode selected.

 **NOTE:** x4 and x8 DRAM based DIMMs can be mixed providing support for RAS features. However, all guidelines for specific RAS features must be followed. x4 DRAM based DIMMs retain Single Device Data Correction (SDDC) in either memory optimized (independent channel) or Advanced ECC modes. x8 DRAM based DIMMs require Advanced ECC mode to gain SDDC.

The following sections provide additional slot population guidelines for each mode.

Advanced ECC (Lockstep)

Advanced ECC mode extends SDDC from x4 DRAM based DIMMs to both x4 and x8 DRAMs. This protects against single DRAM chip failures during normal operation.

Memory sockets A1 and A4 are disabled and you can populate DIMMs in memory sockets A2, A3, A5, and A6.

 **NOTE:** Advanced ECC with Mirroring is not supported.

Memory Optimized (Independent Channel) Mode

This mode supports SDDC only for memory modules that use x4 device width and does not impose any specific slot population requirements.

Memory Sparing

 **NOTE:** To use memory sparing, this feature must be enabled in the System Setup.

In this mode, one rank per channel is reserved as a spare. If persistent correctable errors are detected on a rank, the data from this rank is copied to the spare rank and the failed rank is disabled.

With memory sparing enabled, the system memory available to the operating system is reduced by one rank per channel. For example, in a system with three 8 GB dual-rank DIMMs, the available system memory is: $1/2$ (ranks/channel) \times 3 (DIMMs) \times 8 GB = 12 GB, and not 3 (DIMMs) \times 8 GB = 24 GB.

 **NOTE:** Memory sparing does not offer protection against a multi-bit uncorrectable error.

 **NOTE:** Both Advanced ECC/Lockstep and Optimizer modes support Memory Sparing.

Memory Mirroring

Memory Mirroring offers the strongest DIMM reliability mode compared to all other modes, providing improved uncorrectable multi-bit failure protection. In a mirrored configuration, the total available system memory is one half of the total installed physical memory. Half of the installed memory is used to mirror the active DIMMs. In the event of an uncorrectable error, the system will switch over to the mirrored copy. This ensures SDDC and multi-bit protection.

Memory installation guidelines:

- Memory sockets A1 and A4 are disabled and you can populate DIMMs in memory sockets A2, A3, A5, and A6.
- DIMMs installed in memory sockets with white release tabs must be identical and similar rule applies for sockets with black release tabs. For example, DIMMs installed in sockets A2 and A3 must be identical.

Sample Memory Configurations

The following table shows sample memory configurations for a single processor configuration that follow the appropriate memory guidelines stated in this section.

 **NOTE:** 16 GB quad-rank RDIMMs are not supported.

 **NOTE:** 1R and 2R in the following tables indicate single- and dual-rank DIMMs respectively.

Table 1. Memory Configurations

System Capacity (in GB)	DIMM Size (in GB)	Number of DIMMs	DIMM Rank, Organization, and Frequency	DIMM Slot Population
2	2	1	1R, x8, 1333 MT/s, 1R, x8, 1600 MT/s	A1
4	2	2	1R, x8, 1333 MT/s, 1R, x8, 1600 MT/s	A1, A2
8	2	4	1R, x8, 1333 MT/s,	A1, A2, A3, A4

System Capacity (in GB)	DIMM Size (in GB)	Number of DIMMs	DIMM Rank, Organization, and Frequency	DIMM Slot Population
12	4	3	1R, x8, 1600 MT/s 2R, x8, 1333 MT/s, 2R, x8, 1600 MT/s	A1, A2, A3
24	8	3	2R, x4, 1333 MT/s, 2R, x4, 1600 MT/s	A1, A2, A3
48	16	3	2R, x4, 1333 MT/s, 2R, x4, 1600 MT/s	A1, A2, A3
96	16	6	2R, x4, 1333 MT/s, 2R, x4, 1600 MT/s	A1, A2, A3, A4, A5, A6
128	32	4	4R x4, 1066 MT/s	A1, A2, A3, A4
192	32	6	4R x4, 1066 MT/s	A1, A2, A3, A4, A5, A6

Removing Memory Modules



WARNING: The memory modules are hot to the touch for some time after the system has been powered down. Allow time for the memory modules to cool before handling them. Handle the memory modules by the card edges and avoid touching the components or metallic contacts on the memory module.



CAUTION: Many repairs may only be done by a certified service technician. You should only perform troubleshooting and simple repairs as authorized in your product documentation, or as directed by the online or telephone service and support team. Damage due to servicing that is not authorized by Dell is not covered by your warranty. Read and follow the safety instructions that came with the product.



CAUTION: To ensure proper system cooling, memory-module blanks must be installed in any memory socket that is not occupied. Remove memory-module blanks only if you intend to install memory modules in those sockets.

1. Turn off the system, including any attached peripherals, and disconnect the system from the electrical outlet and peripherals.
2. Open the system.
3. Remove the cooling shroud.
4. Locate the appropriate memory-module socket(s).
5. To release the memory-module blank from the socket, simultaneously press the ejectors on both ends of the memory module socket.



CAUTION: Handle each memory module only on the card edges, making sure not to touch the middle of the memory module or metallic contacts. To avoid damaging the memory module, handle only one memory module at a time.

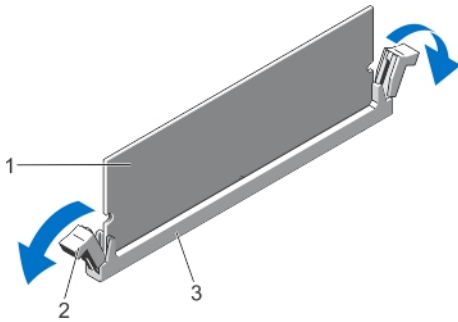



Figure 36. Ejecting The Memory Module

1. memory module
 2. memory-module socket ejectors (2)
 3. memory-module socket
6. If a memory module or a memory-module blank is installed in the socket, remove it.

 **NOTE:** Retain removed memory-module blank(s) for future use.

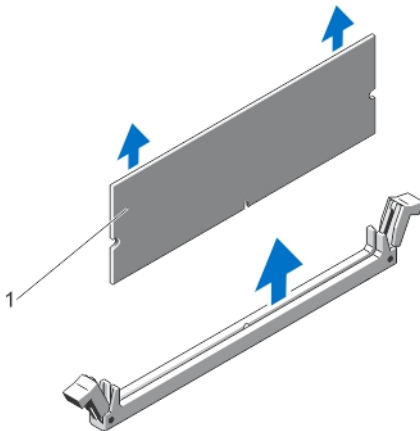



Figure 37. Removing The Memory Module

1. memory module/memory-module blank
7. Install the cooling shroud.
 8. Close the system.
 9. Reconnect the system to its electrical outlet and turn the system on, including any attached peripherals.

Installing Memory Modules

-  **WARNING:** The memory modules are hot to the touch for some time after the system has been powered down. Allow time for the memory modules to cool before handling them. Handle the memory modules by the card edges and avoid touching the components or metallic contacts on the memory module.
-  **CAUTION:** Many repairs may only be done by a certified service technician. You should only perform troubleshooting and simple repairs as authorized in your product documentation, or as directed by the online or telephone service and support team. Damage due to servicing that is not authorized by Dell is not covered by your warranty. Read and follow the safety instructions that came with the product.

CAUTION: To ensure proper system cooling, memory-module blanks must be installed in any memory socket that is not occupied. Remove memory-module blanks only if you intend to install memory modules in those sockets.

1. Turn off the system, including any attached peripherals, and disconnect the system from the electrical outlet.
2. Open the system.
3. If applicable, remove the cooling shroud.
4. Locate the memory-module sockets.

CAUTION: Handle each memory module only by the card edges, making sure not to touch the middle of the memory module or metallic contacts. To avoid damaging the memory module, handle only one memory module at a time.

5. If a memory module or a memory-module blank is installed in the socket, remove it.

NOTE: Retain removed memory-module blank(s) for future use.

6. Align the memory-module's edge connector with the alignment key of the memory-module socket, and insert the memory module in the socket.

NOTE: The memory-module socket has an alignment key that allows you to install the memory module in the socket in only one orientation.

CAUTION: To prevent damage to the memory-module socket during installation, apply pressure at both ends of the memory module evenly. Do not apply pressure to the center of the memory module.

7. Press down on the memory module with your thumbs until the memory module snaps into place.

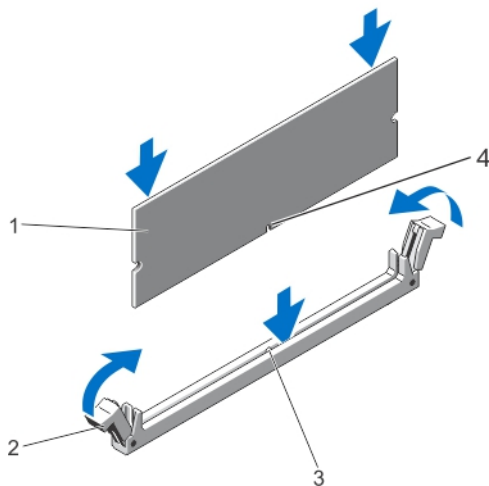

Figure 38. Installing The Memory Module

1. memory module
2. memory-module ejectors
3. memory-module socket alignment key
4. memory-module alignment key

NOTE: When the memory module is properly seated in the socket, the levers on the memory-module socket align with the levers on the other identical sockets that have memory modules installed.

8. Repeat step 4 through step 7 of this procedure to install the remaining memory modules.
9. Replace the cooling shroud.
10. Close the system.

11. Reconnect the system to its electrical outlet and turn on the system, including any attached peripherals.
12. Press <F2> to enter the System Setup, and check the memory settings.
The system should have already changed the value to reflect the newly installed memory.
13. If the value is incorrect, one or more of the memory modules may not be installed properly. Repeat step 4 through step 7 of this procedure, checking to ensure that the memory modules are firmly seated in their sockets.
14. Run the appropriate diagnostic test. For more information, see Using System Diagnostics.

Cooling Fans

The system supports the following:

- An internal cooling fan
- An optional external cooling fan at the back of the chassis

 **NOTE:** When selecting or upgrading your system configuration, verify the system power consumption with the Dell Energy Smart Solution Advisor at dell.com/ESSA to ensure optimum power utilization.

Removing The Internal Cooling Fan

 **CAUTION:** Many repairs may only be done by a certified service technician. You should only perform troubleshooting and simple repairs as authorized in your product documentation, or as directed by the online or telephone service and support team. Damage due to servicing that is not authorized by Dell is not covered by your warranty. Read and follow the safety instructions that came with the product.

 **CAUTION:** Never operate your system with the internal cooling fan removed. System can overheat and result in shutdown of the system and loss of data.

 **CAUTION:** Do not operate the system with the cover removed for a duration exceeding 5 minutes.

1. Turn off the system, including any attached peripherals, and disconnect the system from the electrical outlet and peripherals.
2. If applicable, rotate the system feet inward and lay the system on its side on a flat, stable surface.

 **NOTE:** For systems installed with the wheel assembly, ensure that you lay the system on a sturdy, stable surface with the wheel assembly extending off the edge of the surface.

3. Open the system.
4. Remove the cooling shroud.
5. Disconnect the internal cooling fan power cable from the system board.
6. Release the internal cooling fan power cable from the securing clips on the chassis and system board.

 **CAUTION:** Do not remove or install the internal cooling fan by holding the blades.

7. Press the release tab on the internal cooling fan and, holding the internal cooling fan by the sides, slide it out in the direction of the arrow marked on the fan.

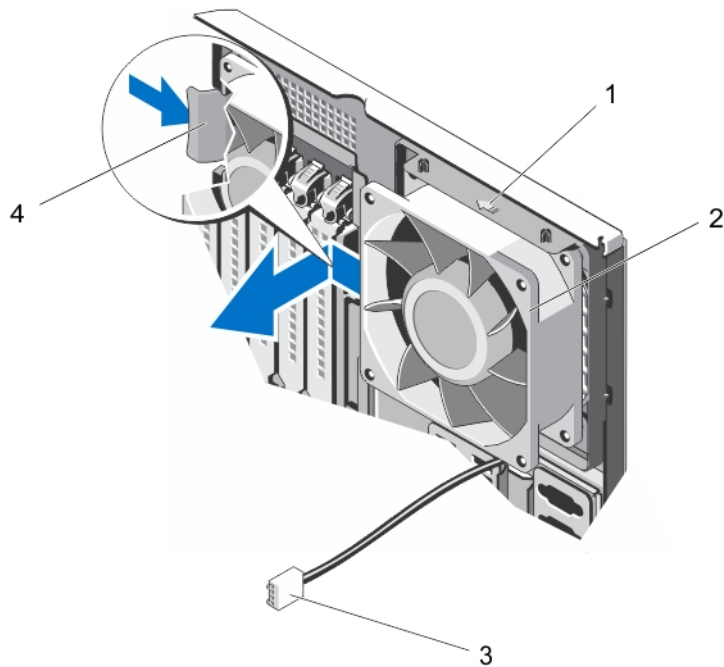

Figure 39. Removing and Installing the Internal Cooling Fan

1. arrow
2. internal cooling fan
3. internal cooling fan power cable
4. release tab

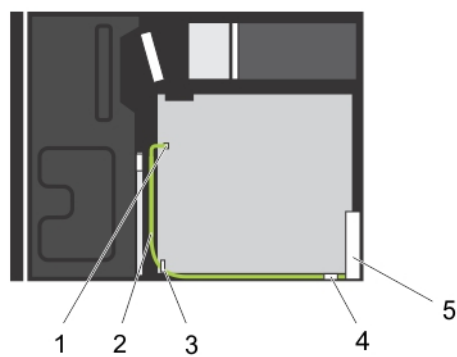



Figure 40. Cabling—Internal Cooling Fan

- | | |
|---|----------------------------------|
| 1. FAN1 power connector on system board | 3. securing clip on system board |
| 2. internal cooling fan power cable | 4. securing clip on chassis |

5. internal cooling fan

Installing The Internal Cooling Fan

 **CAUTION:** Many repairs may only be done by a certified service technician. You should only perform troubleshooting and simple repairs as authorized in your product documentation, or as directed by the online or telephone service and support team. Damage due to servicing that is not authorized by Dell is not covered by your warranty. Read and follow the safety instructions that came with the product.

 **CAUTION:** Do not operate the system with the cover removed for a duration exceeding 5 minutes.

1. Hold the system cooling fan by the sides with the cable end facing the bottom of the chassis.

 **CAUTION:** Do not remove or install the internal cooling fan by holding the blades.

2. Align the four tabs of the internal cooling fan with the four slots on the inside of the chassis.
3. Press and slide the internal cooling fan into the slots till the release tab locks into place.

 **CAUTION:** Do not remove or install the internal cooling fan by holding the blades.

4. Route the internal cooling fan power cable along the side of the chassis and secure the cable using the clips.
5. Connect the internal cooling fan power cable to the FAN1 connector on the system board.
6. Replace the cooling shroud.
7. Close the system.
8. If applicable, place the system upright on a flat, stable surface and rotate the system feet outward.
9. Reconnect the system to its electrical outlet and turn the system on, including any attached peripherals.

Removing The External Cooling Fan

 **CAUTION:** Many repairs may only be done by a certified service technician. You should only perform troubleshooting and simple repairs as authorized in your product documentation, or as directed by the online or telephone service and support team. Damage due to servicing that is not authorized by Dell is not covered by your warranty. Read and follow the safety instructions that came with the product.

 **CAUTION:** Do not operate the system with the cover removed for a duration exceeding 5 minutes.

1. Turn off the system, including any attached peripherals, and disconnect the system from the electrical outlet and peripherals.
2. If applicable, rotate the system feet inward and lay the system on its side on a flat, stable surface.

 **NOTE:** For systems installed with the wheel assembly, ensure that you lay the system on a sturdy, stable surface with the wheel assembly extending off the edge of the surface.

3. Open the system.
4. Remove the cooling shroud.
5. Disconnect the external cooling fan power cable from the system board and free the power cable from the clips.
6. Remove the four screws that secure the external cooling fan to the chassis.
7. Rotate the top of the external cooling fan away from the system until the hooks are free of the slots and remove the fan.
8. Remove the external cooling fan power cable from of the system through the slot in the back of the chassis.
9. Install the cooling shroud.
10. Close the system.

11. If applicable, place the system upright on a flat, stable surface and rotate the system feet outward.
12. Reconnect the system to its electrical outlet and turn the system on, including any attached peripherals.

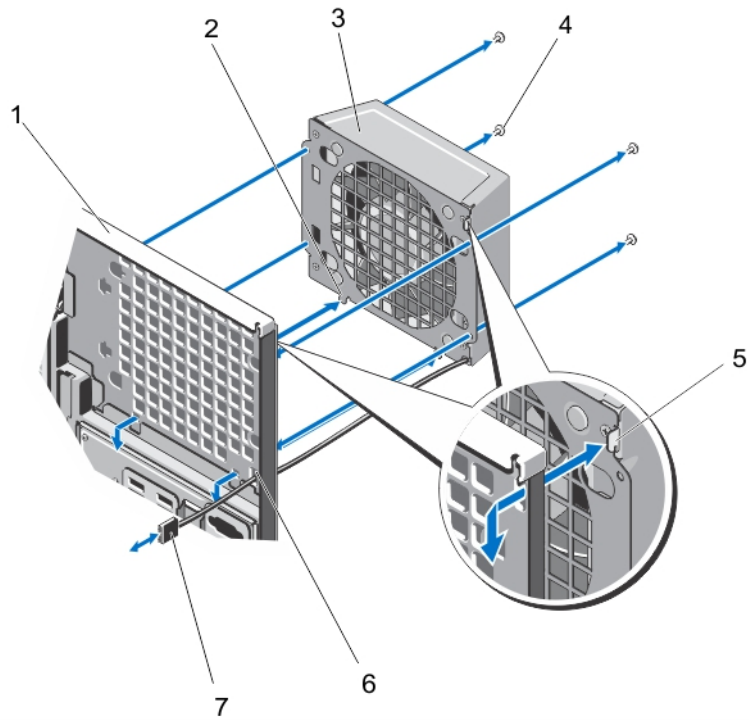

Figure 41. Removing and Installing the External Cooling Fan

- | | |
|-------------------------------|--|
| 1. back of the system chassis | 5. upper hook |
| 2. lower hooks (2) | 6. external cooling fan power cable slot |
| 3. external cooling fan | 7. external cooling fan power cable |
| 4. screws (4) | |

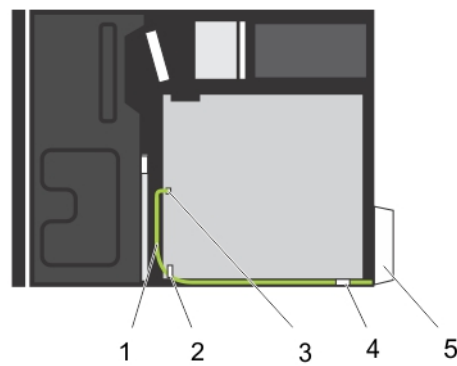



Figure 42. Cabling—External Cooling Fan

- | | |
|-------------------------------------|----------------------------------|
| 1. external cooling fan power cable | 2. securing clip on system board |
|-------------------------------------|----------------------------------|

3. FAN2 power connector on system board
4. securing clip on chassis
5. external cooling fan

Installing The External Cooling Fan

 **CAUTION:** Many repairs may only be done by a certified service technician. You should only perform troubleshooting and simple repairs as authorized in your product documentation, or as directed by the online or telephone service and support team. Damage due to servicing that is not authorized by Dell is not covered by your warranty. Read and follow the safety instructions that came with the product.

 **CAUTION:** Do not operate the system with the cover removed for a duration exceeding 5 minutes.

1. Turn off the system, including any attached peripherals, and disconnect the system from the electrical outlet and peripherals.
2. If applicable, rotate the system feet inward and lay the system on its side on a flat, stable surface.
 **NOTE:** For systems installed with the wheel assembly, ensure that you lay the system on a sturdy, stable surface with the wheel assembly extending off the edge of the surface.
3. Open the system.
4. Remove the cooling shroud.
5. Route the external cooling fan power cable into the system through the slot at the back of the chassis.
6. Align and insert the two lower hooks on the external cooling fan into the corresponding slots on the back of the chassis.
7. Rotate the top of the external cooling fan toward the chassis till the upper hook locks into place.
8. Use the four screws to secure the external cooling fan to the chassis.
9. Secure the external cooling fan power cable using the clips inside the chassis.
10. Connect the external cooling fan power cable to the FAN2 connector on the system board.
11. Install the cooling shroud.
12. Close the system.
13. If applicable, place the system upright on a flat, stable surface and rotate the system feet outward.
14. Reconnect the system to its electrical outlet and turn the system on, including any attached peripherals.

Internal USB Memory Key (Optional)

An optional USB memory key installed inside your system can be used as a boot device, security key, or mass storage device. The USB connector must be enabled by the **Internal USB Port** option in the **Integrated Devices** screen of the System Setup.

To boot from the USB memory key, configure the USB memory key with a boot image and then specify the USB memory key in the boot sequence in the System Setup.

 **NOTE:** To locate the internal USB connector (INT USB) on the system board, see System Board Connectors.

Replacing The Internal USB Key

⚠ CAUTION: Many repairs may only be done by a certified service technician. You should only perform troubleshooting and simple repairs as authorized in your product documentation, or as directed by the online or telephone service and support team. Damage due to servicing that is not authorized by Dell is not covered by your warranty. Read and follow the safety instructions that came with the product.

1. Turn off the system, including any attached peripherals, and disconnect the system from the electrical outlet and peripherals.
2. If applicable, rotate the system feet inward and lay the system on its side on a flat, stable surface.

✎ NOTE: For systems installed with the wheel assembly, ensure that you lay the system on a sturdy, stable surface with the wheel assembly extending off the edge of the surface.

3. Open the system.
4. Locate the USB connector (INT USB) or the USB key on the system board.
5. If applicable, remove the USB key.
6. Insert the new USB key into the USB connector.
7. Close the system.
8. If applicable, place the system upright on a flat, stable surface and rotate the system feet outward.
9. Reconnect the system to its electrical outlet and turn the system on, including any attached peripherals.
10. Enter the System Setup and verify that the USB key is detected by the system.

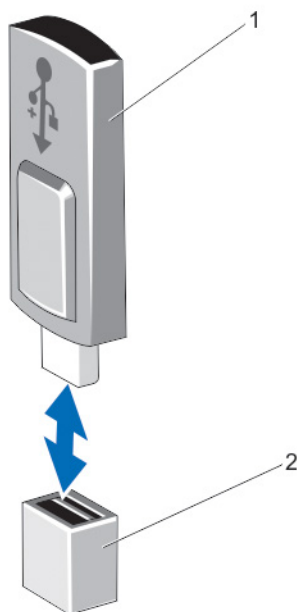

Figure 43. Replacing the Internal USB Key

1. USB key

PCIe Card Holder (Optional)

Removing The PCIe Card Holder

⚠ CAUTION: Many repairs may only be done by a certified service technician. You should only perform troubleshooting and simple repairs as authorized in your product documentation, or as directed by the online or telephone service and support team. Damage due to servicing that is not authorized by Dell is not covered by your warranty. Read and follow the safety instructions that came with the product.

1. Turn off the system, including any attached peripherals, and disconnect the system from the electrical outlet and peripherals.
2. If applicable, rotate the system feet inward and lay the system on its side on a flat, stable surface.
✎ NOTE: For systems installed with the wheel assembly, ensure that you lay the system on a sturdy, stable surface with the wheel assembly extending off the edge of the surface.
3. Open the system.
4. Press the tabs and pull the PCIe card holder from the chassis.
5. Lift the PCIe card holder out of the chassis.
6. Close the system.
7. If applicable, place the system upright on a flat, stable surface and rotate the system feet outward.
8. If applicable, reconnect the system to its electrical outlet and turn the system on, including any attached peripherals.

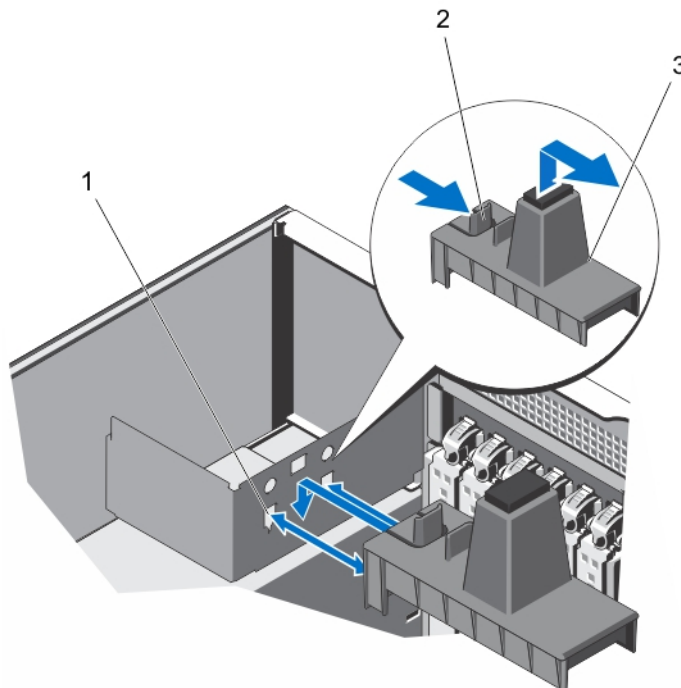



Figure 44. Removing and Installing the PCIe Card Holder

1. slots (2)
2. tabs (2)
3. PCIe card holder

Installing The PCIe Card Holder

 **CAUTION:** Many repairs may only be done by a certified service technician. You should only perform troubleshooting and simple repairs as authorized in your product documentation, or as directed by the online or telephone service and support team. Damage due to servicing that is not authorized by Dell is not covered by your warranty. Read and follow the safety instructions that came with the product.

1. Turn off the system, including any attached peripherals, and disconnect the system from the electrical outlet and peripherals.
2. If applicable, rotate the system feet inward and lay the system on its side on a flat, stable surface.
 -  **NOTE:** For systems installed with the wheel assembly, ensure that you lay the system on a sturdy, stable surface with the wheel assembly extending off the edge of the surface.
3. Open the system.
4. Align the PCIe card holder with the slots on the chassis and push it down until seated.
5. Close the system.
6. If applicable, place the system upright on a flat, stable surface and rotate the system feet outward.
7. Reconnect the system to its electrical outlet and turn the system on, including any attached peripherals.

Expansion Cards

Expansion Card Installation Guidelines

Table 2. Supported PCI Express Expansion Cards

Expansion Card Slot	Processor Connection	Height	Length	Link Width	Slot Width
1	Platform Controller Hub	Full Height	Half Length	x4	x8
2	Platform Controller Hub	Full Height	Full Length	x1	x8
3	Processor 1	Full Height	Full Length	x16	x16
4	Processor 1	Full Height	Full Length	x4	x8
6	Processor 1	Full Height	Half Length	x4	x8

 **NOTE:** Slot 5 is not applicable.

 **NOTE:** Only slot 3, 4, and 6 support Generation 3 PCIe expansion cards.

 **NOTE:** The expansion cards are not hot-swappable.

The following table provides a guide for installing expansion cards to ensure proper cooling and mechanical fit. The expansion cards with the highest priority must be installed first using the slot priority indicated. All other expansion cards must be installed in card priority and slot priority order.

Table 3. Expansion Card Installation Order

Card Priority	Card Type	Slot Priority	Maximum Allowed
1	GPU	3	1
2	External RAID	1, 4, 3, 6	1
3	Internal RAID	6, 4, 3, 1	1
4	10 Gb NICs	4, 3, 6	3
5	FC8 HBA	4, 3, 1, 6	4
6	CNAs	4, 3, 1, 6	4
7	1 Gb NICs	2, 4, 3, 1, 6	5
8	Non-RAID	4, 3, 1, 6	1
9	Internal tape adapter	2, 4, 3, 1, 6	1

 **NOTE:** If you are installing a double-width GPU card in slot 3, you cannot install an expansion card in slot 2.

GPU Card Installation Guidelines

- Ensure that the GPU cable is available.
- The system supports one single- or double-width GPU card in PCIe slot 3.
- Only single-width GPU Q4000 and dual-width GPU Q6000 are supported.
- Systems installed with the double-width GPU card supports only one 5.25 inch removable media storage device.
- The GPU card must be installed on a system with a redundant 750 W AC power supply.
- The GPU card power cable must be connected to the GPU power connector CN11 on the power distribution board.

Removing An Expansion Card

 **CAUTION:** Many repairs may only be done by a certified service technician. You should only perform troubleshooting and simple repairs as authorized in your product documentation, or as directed by the online or telephone service and support team. Damage due to servicing that is not authorized by Dell is not covered by your warranty. Read and follow the safety instructions that came with the product.

1. Turn off the system, including any attached peripherals, and disconnect the system from the electrical outlet and peripherals.
2. If applicable, rotate the system feet inward and lay the system on its side on a flat, stable surface.

 **NOTE:** For systems installed with the wheel assembly, ensure that you lay the system on a sturdy, stable surface with the wheel assembly extending off the edge of the surface.

3. Open the system.
4. If applicable, remove the PCIe card holder.
5. If applicable, press and disconnect the two SAS cables from the expansion card.
6. If applicable, disconnect the P3 power cable from the system board.
7. From inside the system, press and push out the expansion card release latch to open it.
8. Holding the card by its edge, pull the card to disengage from the connector and lift the card out of the chassis.
9. If you are removing the card permanently, install a filler bracket in the empty card slot.

NOTE: Filler brackets must be installed over empty expansion-card slots to maintain FCC certification of the system. The brackets also keep dust and dirt out of the system and aid in proper cooling and airflow inside the system.

10. From outside the system, rotate the expansion card latch toward the system until it snaps into place.
11. If applicable, install the PCIe card holder.
12. Close the system.
13. If applicable, place the system upright on a flat, stable surface and rotate the system feet outward.
14. Reconnect the system to its electrical outlet and turn the system on, including any attached peripherals.

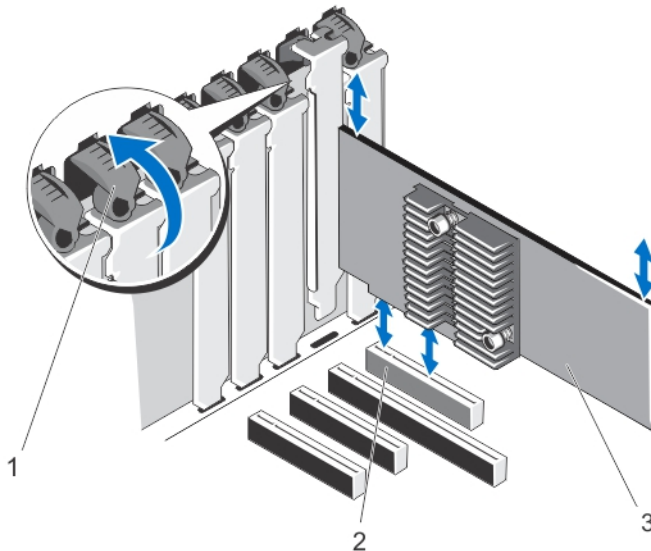

Figure 45. Removing and Installing the Expansion Card

1. expansion card latch
2. expansion card connector
3. expansion card

Installing An Expansion Card

CAUTION: Many repairs may only be done by a certified service technician. You should only perform troubleshooting and simple repairs as authorized in your product documentation, or as directed by the online or telephone service and support team. Damage due to servicing that is not authorized by Dell is not covered by your warranty. Read and follow the safety instructions that came with the product.

1. Unpack the expansion card and prepare it for installation.
For instructions, see the documentation accompanying the card.
2. Turn off the system, including any attached peripherals, and disconnect the system from the electrical outlet and peripherals.
3. If applicable, rotate the system feet inward and lay the system on its side on a flat, stable surface.

NOTE: For systems installed with the wheel assembly, ensure that you lay the system on a sturdy, stable surface with the wheel assembly extending off the edge of the surface.

4. Open the system.

5. If applicable, remove the PCIe card holder.
6. From inside the system, press and push out the expansion card release latch to open it.
7. If you are installing a new expansion card, remove the filler bracket.
 -  **NOTE:** Keep the filler bracket in case you need to remove the expansion card. Filler brackets must be installed over empty expansion-card slots to maintain FCC certification of the system. The brackets also keep dust and dirt out of the system and aid in proper cooling and airflow inside the system.
8. Holding the card by its edges, position the card so that the card-edge connector aligns with the expansion card connector.
9. Insert the card-edge connector into the expansion card connector until the card is fully seated.
10. From outside the system, rotate the expansion card latch toward the system until it snaps into place.
11. If applicable, connect the two SAS cables to the expansion card.
12. If applicable, connect the P3 power cable to the system board.
13. If applicable, install the PCIe card holder.
14. Close the system.
15. If applicable, place the system upright on a flat, stable surface and rotate the system feet outward.
16. Reconnect the system to its electrical outlet and turn the system on, including any attached peripherals.

Removing A GPU Card

 **CAUTION:** Many repairs may only be done by a certified service technician. You should only perform troubleshooting and simple repairs as authorized in your product documentation, or as directed by the online or telephone service and support team. Damage due to servicing that is not authorized by Dell is not covered by your warranty. Read and follow the safety instructions that came with the product.

1. Turn off the system, including any attached peripherals, and disconnect the system from the electrical outlet and peripherals.
2. If applicable, rotate the system feet inward and lay the system on its side on a flat, stable surface.

 **NOTE:** For systems installed with the wheel assembly, ensure that you lay the system on a sturdy, stable surface with the wheel assembly extending off the edge of the surface.

3. Open the system.
4. Remove the PCIe card holder.

 **CAUTION:** Do not use excessive force when removing the cables as it can damage the connectors.

5. Disconnect the cables from the GPU card.
6. From inside the system, press and push out the expansion card release latch securing the GPU card.

 **NOTE:** If you are removing a double-width GPU card, you must open the two expansion card latches securing the card.

7. Holding the card by its edge, pull the card to disengage from the connector and lift the card out of the chassis.
8. Install the filler brackets, if you are not replacing the GPU card.

 **NOTE:** Filler brackets must be installed over empty expansion-card slots to maintain FCC certification of the system. The brackets also keep dust and dirt out of the system and aid in proper cooling and airflow inside the system.

9. From outside the system, rotate the expansion card latch(es) toward the system until it snaps into place.
10. Install the PCIe card holder.
11. Close the system.
12. If applicable, place the system upright on a flat, stable surface and rotate the system feet outward.

13. Reconnect the system to its electrical outlet and turn the system on, including any attached peripherals.

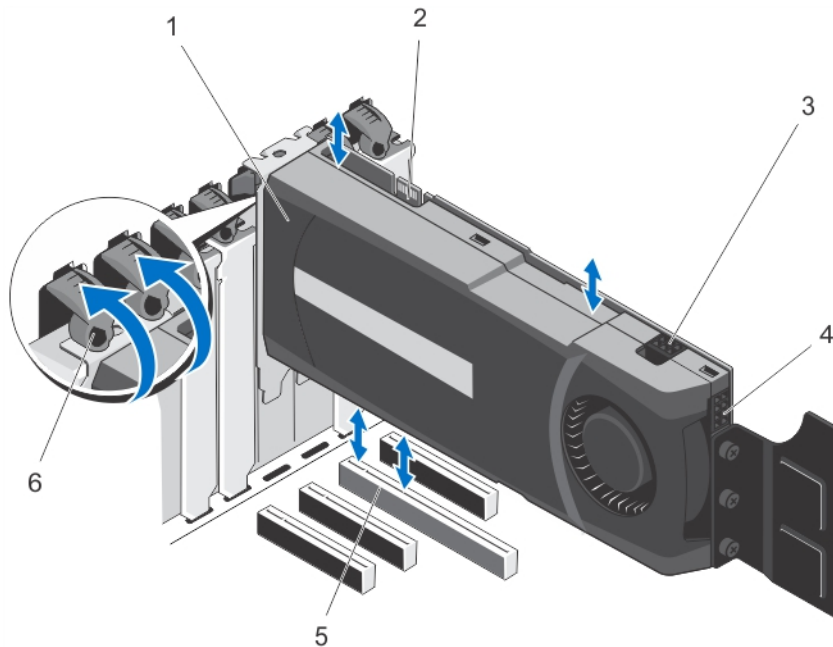



Figure 46. Removing and Installing the GPU Card

1. GPU card (double-width)
2. SLI data connector
3. 6-pin GPU card power connector
4. 8-pin GPU card power connector
5. x16 connector
6. expansion-card latches (2)

Installing A GPU Card

CAUTION: Many repairs may only be done by a certified service technician. You should only perform troubleshooting and simple repairs as authorized in your product documentation, or as directed by the online or telephone service and support team. Damage due to servicing that is not authorized by Dell is not covered by your warranty. Read and follow the safety instructions that came with the product.

1. Turn off the system, including any attached peripherals, and disconnect the system from the electrical outlet and peripherals.
2. If applicable, place the system upright on a flat, stable surface and rotate the system feet outward.
NOTE: For systems installed with the wheel assembly, ensure that you lay the system on a sturdy, stable surface with the wheel assembly extending off the edge of the surface.
3. Open the system.
4. Remove the PCIe card holder.
5. Locate the x16 slot on the system board.
6. From inside the system, press and push out the expansion card release latch for the x16 slot.

 **NOTE:** If you are installing a double-width GPU card, you must open the two expansion card latches to secure the card.

7. If applicable, remove the filler brackets.
8. Insert the GPU card into the x16 slot.
9. From outside the system, rotate the expansion card latch(es) toward the system until it snaps into place.
10. Connect the cables to the GPU card.
11. Install the PCIe card holder.
12. Close the system.
13. If applicable, place the system upright on a flat, stable surface and rotate the system feet outward.
14. Reconnect the system to its electrical outlet and turn the system on, including any attached peripherals.

iDRAC Ports Card

The iDRAC ports card consists of the SD vFlash card slot and an iDRAC port. The iDRAC ports card is used for advanced management of the system.

An SD vFlash card is a Secure Digital (SD) card that plugs into the SD vFlash card slot in the system. It provides persistent on-demand local storage and a custom deployment environment that allows automation of server configuration, scripts, and imaging. It emulates USB device(s). For more information, see the *iDRAC7 User's Guide* at dell.com/support/manuals.

Removing The iDRAC Ports Card

 **CAUTION:** Many repairs may only be done by a certified service technician. You should only perform troubleshooting and simple repairs as authorized in your product documentation, or as directed by the online or telephone service and support team. Damage due to servicing that is not authorized by Dell is not covered by your warranty. Read and follow the safety instructions that came with the product.

1. Turn off the system, including any attached peripherals, and disconnect the system from the electrical outlet and peripherals.
2. If applicable, rotate the system feet inward and lay the system on its side on a flat, stable surface.

 **NOTE:** For systems installed with the wheel assembly, ensure that you lay the system on a sturdy, stable surface with the wheel assembly extending off the edge of the surface.

3. Open the system.
4. Remove the cooling shroud.
5. Remove the screw securing the iDRAC ports card to the back of the chassis.
6. Pull the iDRAC ports card to disengage it from the iDRAC ports card connector and remove the card from the chassis.
7. If you are not replacing the iDRAC ports card, insert the filler bracket and secure it with a screw.

 **NOTE:** Filler brackets must be installed over empty card slots to maintain FCC certification of the system. The brackets also keep dust and dirt out of the system and aid in proper cooling and airflow inside the system.

8. Install the cooling shroud.
9. Close the system.
10. If applicable, place the system upright on a flat, stable surface and rotate the system feet outward.
11. Reconnect the system to its electrical outlet and turn the system on, including any attached peripherals.

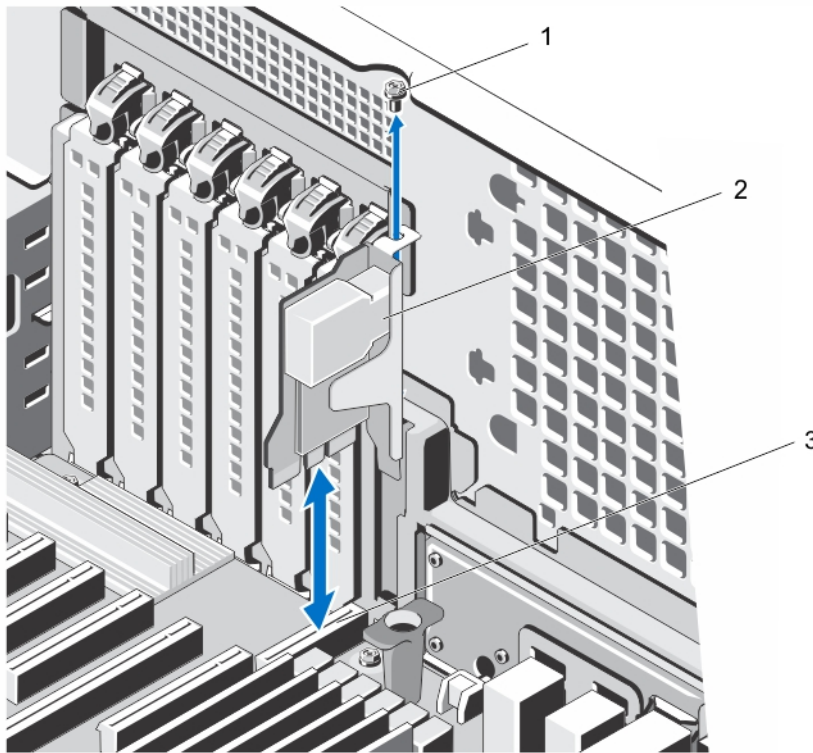

Figure 47. Removing and Installing the iDRAC Ports Card

1. screw
2. iDRAC ports card
3. iDRAC ports card connector

Installing The iDRAC Ports Card

⚠ CAUTION: Many repairs may only be done by a certified service technician. You should only perform troubleshooting and simple repairs as authorized in your product documentation, or as directed by the online or telephone service and support team. Damage due to servicing that is not authorized by Dell is not covered by your warranty. Read and follow the safety instructions that came with the product.

1. Turn off the system, including any attached peripherals, and disconnect the system from the electrical outlet and peripherals.
2. If applicable, rotate the system feet inward and lay the system on its side on a flat, stable surface.
 - ✎ NOTE:** For systems installed with the wheel assembly, ensure that you lay the system on a sturdy, stable surface with the wheel assembly extending off the edge of the surface.
3. Open the system.
4. Remove the cooling shroud.
5. If there is a filler bracket in the iDRAC ports card slot, remove the screw and lift the filler bracket out of the system.
6. Insert the iDRAC ports card into the connector on the system board.
7. Secure the iDRAC ports card using the screw.
8. Install the cooling shroud.

9. Close the system.
10. If applicable, place the system upright on a flat, stable surface and rotate the system feet outward.
11. Reconnect the system to its electrical outlet and turn the system on, including any attached peripherals.

Replacing An SD vFlash Card

1. Locate the SD vFlash card slot on the system.
2. To remove the installed SD vFlash card, push inward on the card to release it, and pull the card from the card slot.

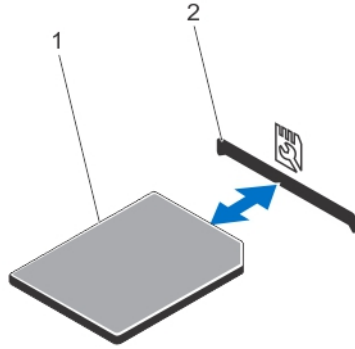





Figure 48. Removing and Installing the SD vFlash Card

1. SD vFlash card
2. SD vFlash card slot
3. To install the SD vFlash card, hold the card with the label side facing up and insert the contact-pin end of the card into the SD vFlash card slot.
 -  **NOTE:** The slot is keyed to ensure correct insertion of the card.
4. Press inward on the SD vFlash card to lock it into the slot.

Internal Dual SD Module

-  **NOTE:** When the **Redundancy** option is set to **Mirror Mode** in the **Integrated Devices** screen of the System Setup, the information is replicated from one SD card to another.

Removing An Internal Dual SD Module

-  **CAUTION:** Many repairs may only be done by a certified service technician. You should only perform troubleshooting and simple repairs as authorized in your product documentation, or as directed by the online or telephone service and support team. Damage due to servicing that is not authorized by Dell is not covered by your warranty. Read and follow the safety instructions that came with the product.

1. Turn off the system, including any attached peripherals, and disconnect the system from the electrical outlet and peripherals.
2. If applicable, rotate the system feet inward and lay the system on its side on a flat, stable surface.
 -  **NOTE:** For systems installed with the wheel assembly, ensure that you lay the system on a sturdy, stable surface with the wheel assembly extending off the edge of the surface.
3. Open the system.
4. Locate the internal dual SD module on the system board.

5. If applicable, remove the SD card(s).
6. Pull out the internal dual SD module from the system board.
7. Close the system.
8. If applicable, place the system upright on a flat, stable surface and rotate the system feet outward.
9. Reconnect the system to its electrical outlet and turn the system on, including any attached peripherals.

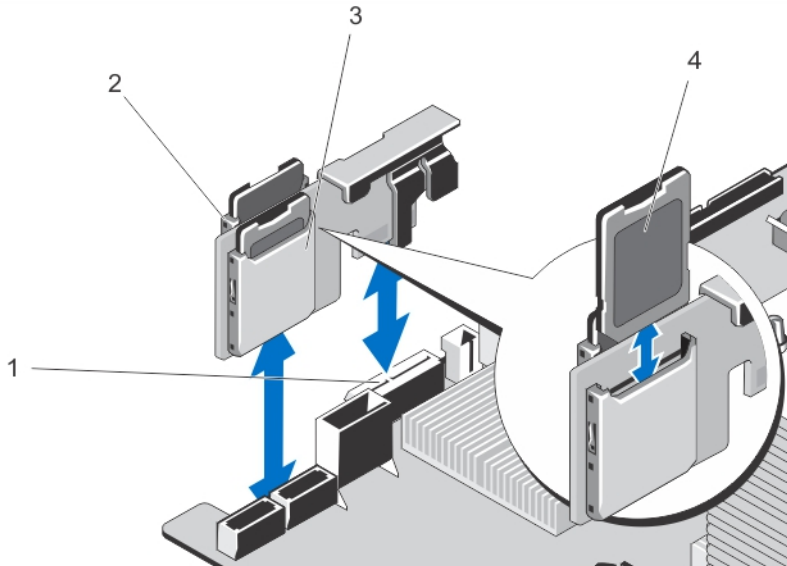

Figure 49. Removing and Installing the Internal Dual SD Module

1. SD card connector on system board
2. SD card slot 1
3. SD card slot 2
4. SD card

Installing An Internal Dual SD Module

CAUTION: Many repairs may only be done by a certified service technician. You should only perform troubleshooting and simple repairs as authorized in your product documentation, or as directed by the online or telephone service and support team. Damage due to servicing that is not authorized by Dell is not covered by your warranty. Read and follow the safety instructions that came with the product.

1. Turn off the system, including any attached peripherals, and disconnect the system from the electrical outlet and peripherals.
2. If applicable, rotate the system feet inward and lay the system on its side on a flat, stable surface.
 - NOTE:** For systems installed with the wheel assembly, ensure that you lay the system on a sturdy, stable surface with the wheel assembly extending off the edge of the surface.
3. Open the system.
4. Locate the internal dual SD module connector on the system board.
5. Align the connectors on the system board with the connectors on the internal dual SD module.
6. Press the internal dual SD module until it is seated on the system board.
7. Close the system.
8. If applicable, place the system upright on a flat, stable surface and rotate the system feet outward.

9. Reconnect the system to its electrical outlet and turn the system on, including any attached peripherals.

Internal SD Card

Removing An Internal SD Card



 **CAUTION:** Many repairs may only be done by a certified service technician. You should only perform troubleshooting and simple repairs as authorized in your product documentation, or as directed by the online or telephone service and support team. Damage due to servicing that is not authorized by Dell is not covered by your warranty. Read and follow the safety instructions that came with the product.

1. Turn off the system, including any attached peripherals, and disconnect the system from the electrical outlet and peripherals.
2. If applicable, rotate the system feet inward and lay the system on its side on a flat, stable surface.
 **NOTE:** For systems installed with the wheel assembly, ensure that you lay the system on a sturdy, stable surface with the wheel assembly extending off the edge of the surface.
3. Open the system.
4. Locate the SD card slot on the internal dual SD module.
5. Press inward on the SD card to release it from the slot and remove the card.
6. Close the system.
7. If applicable, place the system upright on a flat, stable surface and rotate the system feet outward.
8. Reconnect the system to its electrical outlet and turn the system on, including any attached peripherals.

Installing An Internal SD Card

 **CAUTION:** Many repairs may only be done by a certified service technician. You should only perform troubleshooting and simple repairs as authorized in your product documentation, or as directed by the online or telephone service and support team. Damage due to servicing that is not authorized by Dell is not covered by your warranty. Read and follow the safety instructions that came with the product.

 **NOTE:** To use an SD card with your system, ensure that the **Internal SD Card Port** is enabled in the System Setup.

1. Turn off the system, including any attached peripherals, and disconnect the system from the electrical outlet and peripherals.
2. If applicable, rotate the system feet inward and lay the system on its side on a flat, stable surface.
 **NOTE:** For systems installed with the wheel assembly, ensure that you lay the system on a sturdy, stable surface with the wheel assembly extending off the edge of the surface.
3. Open the system.
4. Locate the SD card slot on the internal dual SD module.
5. Orient the SD card appropriately and insert the contact-pin end of the card into the slot.
 **NOTE:** The slot is keyed to ensure correct insertion of the card.
6. Press the card into the card slot to lock it into place.
7. Close the system.
8. If applicable, place the system upright on a flat, stable surface and rotate the system feet outward.
9. Reconnect the system to its electrical outlet and turn the system on, including any attached peripherals.

Processors

Your system supports one of the following processors:

- One Intel Xeon processor E5-2400 product family
- One Intel Xeon processor E5-1410
- One Intel Pentium processor 1400

Use the procedures in this section to replace or upgrade your processor.

 **NOTE:** When selecting or upgrading your system configuration, verify the system power consumption with the Dell Energy Smart Solution Advisor at dell.com/ESSA to ensure optimum power utilization.

Removing A Processor

 **CAUTION:** Many repairs may only be done by a certified service technician. You should only perform troubleshooting and simple repairs as authorized in your product documentation, or as directed by the online or telephone service and support team. Damage due to servicing that is not authorized by Dell is not covered by your warranty. Read and follow the safety instructions that came with the product.

1. If you are upgrading your system, download the latest system BIOS version from dell.com/support and follow the instructions included in the compressed download file to install the update on your system.

 **NOTE:** You can update the system BIOS using the Lifecycle Controller.

2. Turn off the system, including any attached peripherals, and disconnect the system from the electrical outlet and peripherals.
3. When disconnected from the power source, press and hold the power button for 3 seconds to fully drain the system of stored power prior to removing the cover.
4. If applicable, rotate the system feet inward and lay the system on its side on a flat, stable surface.

 **NOTE:** For systems installed with the wheel assembly, ensure that you lay the system on a sturdy, stable surface with the wheel assembly extending off the edge of the surface.

5. Open the system.
6. Remove the cooling shroud.

 **WARNING:** The heat sink and processor are hot to the touch for some time after the system has been powered down. Allow the heat sink and processor to cool before handling them.

 **CAUTION:** Never remove the heat sink from a processor unless you intend to remove the processor. The heat sink is necessary to maintain proper thermal conditions.

7. Loosen the first screw that secures the heat sink to the system board.
8. Wait 30 seconds for the heat sink to loosen from the processor and remove the screw diagonally opposite the first screw.
9. Repeat steps 7 and 8 for the other pair of screws.
10. Lift the heat sink up from the processor and set the heat sink aside upside-down (thermal grease side facing up).

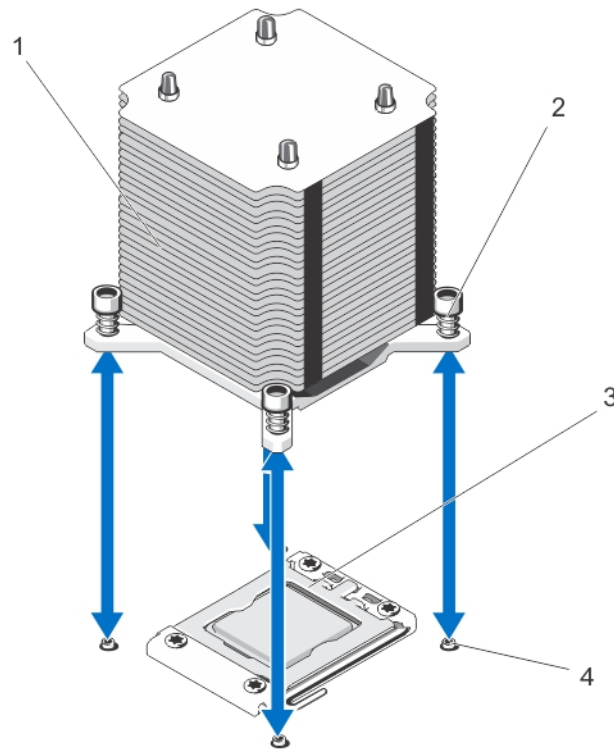

Figure 50. Removing and Installing the Heat Sink

- 1. heat sink
- 2. captive screws (4)
- 3. processor shield
- 4. standoffs (4)

⚠ CAUTION: The processor is held in its socket under strong pressure. Be aware that the release lever can spring up suddenly if not firmly grasped.

11. Position your thumb firmly over the processor socket-release lever and release the lever from the locked position by pushing down and out from under the tab. Rotate the lever 90 degrees upwards.
12. Rotate the processor shield upward and out of the way.

⚠ CAUTION: The socket pins are fragile and can be permanently damaged. Be careful not to bend the pins in the socket when removing the processor out of the socket.

13. Lift the processor out of the socket and leave the release lever up so that the socket is ready for the new processor.

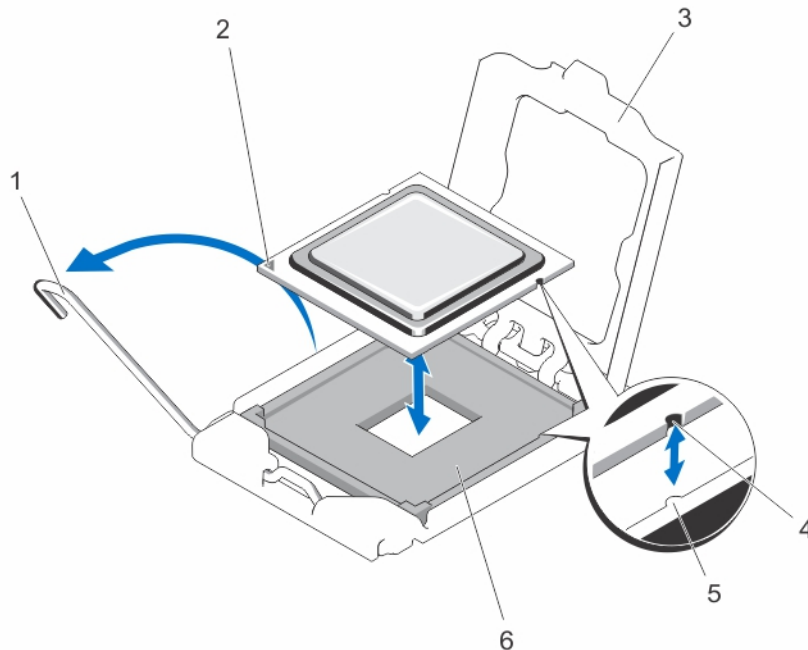

Figure 51. Removing and Installing a Processor

- | | |
|-------------------------|--------------------|
| 1. socket release lever | 5. socket keys (2) |
| 2. processor | 6. notch |
| 3. processor shield | |
| 4. ZIF socket | |

NOTE: After removing the processor, place it in an antistatic container for reuse, return, or temporary storage. Do not touch the bottom of the processor. Touch only the edges of the processor.

Installing A Processor

CAUTION: Many repairs may only be done by a certified service technician. You should only perform troubleshooting and simple repairs as authorized in your product documentation, or as directed by the online or telephone service and support team. Damage due to servicing that is not authorized by Dell is not covered by your warranty. Read and follow the safety instructions that came with the product.

1. If you are upgrading your system, download the latest system BIOS version from dell.com/support and follow the instructions included in the compressed download file to install the update on your system.

NOTE: You can update the system BIOS using the Lifecycle Controller.

2. Unpack the new processor.
If the processor has previously been used in a system, remove any remaining thermal grease from the processor using a lint-free cloth.
3. Align the processor with the socket keys on the ZIF socket.
4. To install the processor in the socket:

 **CAUTION: Positioning the processor incorrectly can permanently damage the system board or the processor. Be careful not to bend the pins in the socket.**

- a) With the release lever on the processor socket in the open position, align the processor with the socket keys and set the processor lightly in the socket.

 **CAUTION: Do not use force to seat the processor. When the processor is positioned correctly, it engages easily into the socket.**

- b) Close the processor shield.
- c) Rotate the socket release lever down until it snaps into place.

5. Install the heat sink:

 **CAUTION: Applying too much thermal grease can result in excess grease coming in contact with and contaminating the processor socket.**

- a) If applicable, open the grease applicator included with your processor kit and apply all of the thermal grease in the applicator to the center of the topside of the new processor.
- b) Place the heat sink onto the processor.
- c) Tighten the four screws to secure the heat sink to the system board.

 **NOTE:** Do not over-tighten the heat sink retention screws when installing the heat sink. To prevent over-tightening, tighten the retention screw until resistance is felt, and stop once the screw is seated. The screw tension should be no more than 6 in-lb (6.9 kg-cm).

6. Install the cooling shroud.
7. Close the system.
8. If applicable, place the system upright on a flat, stable surface and rotate the system feet outward.
9. Reconnect the system to its electrical outlet and turn the system on, including any attached peripherals.
10. Press <F2> to enter the System Setup and check that the processor information matches the new system configuration.
11. Run the system diagnostics to verify that the new processor operates correctly.

Redundant AC Power Supply

Your system supports up to two 495 W or 750 W redundant AC power supplies.

When two identical power supplies are installed, the power supply configuration is redundant (1 + 1). In redundant mode, power is supplied to the system equally from both power supplies to maximize efficiency.

When only one power supply is installed, the power supply configuration is non-redundant (1 + 0). Power is supplied to the system only by the single power supply.

 **NOTE:** If two power supplies are used, they must be of the same type and have the same maximum output power.

 **NOTE:** Redundant power supplies are supported on systems with hot-swappable hard drives only.

 **NOTE:** When selecting or upgrading your system configuration, verify the system power consumption with the Dell Energy Smart Solution Advisor at dell.com/ESSA to ensure optimum power utilization.

Removing A Redundant AC Power Supply

 **CAUTION: Many repairs may only be done by a certified service technician. You should only perform troubleshooting and simple repairs as authorized in your product documentation, or as directed by the online or telephone service and support team. Damage due to servicing that is not authorized by Dell is not covered by your warranty. Read and follow the safety instructions that came with the product.**

CAUTION: The system requires at least one power supply for normal operation. On power-redundant systems, remove and replace only one power supply at a time in a system that is powered on.

NOTE: For systems in rack mode, you may have to unlatch and lift the optional cable management arm if it interferes with power supply removal. For information about the cable management arm, see the system's rack documentation.

1. Disconnect the power cable from the power source.
2. Remove the power cables from the cable strap of the power supply that you intend to remove.
3. Disconnect the power cable from the power supply.
4. Press the release latch and slide the power supply out of the chassis.

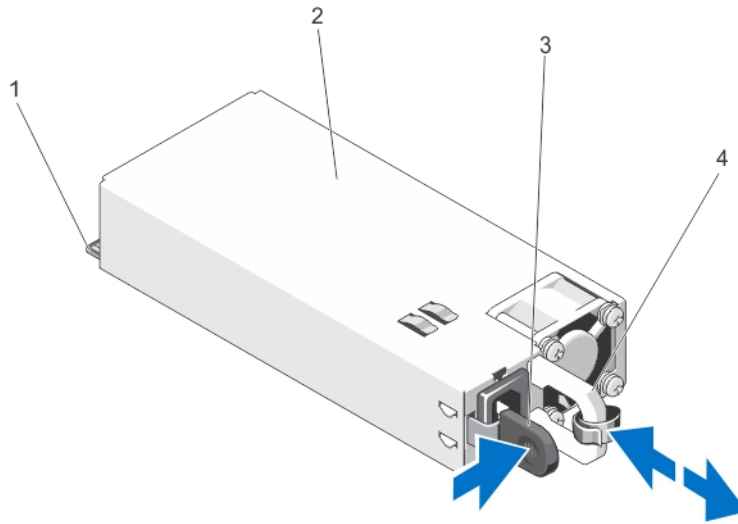

Figure 52. Removing and Installing a Redundant AC Power Supply

1. connector
2. redundant AC power supply
3. release latch
4. power supply handle

Installing A Redundant AC Power Supply

CAUTION: Many repairs may only be done by a certified service technician. You should only perform troubleshooting and simple repairs as authorized in your product documentation, or as directed by the online or telephone service and support team. Damage due to servicing that is not authorized by Dell is not covered by your warranty. Read and follow the safety instructions that came with the product.

1. Verify that both the power supplies are the same type and have the same maximum output power.
NOTE: The maximum output power (shown in Watts) is listed on the power supply label.
2. If applicable, remove the power supply blank.
3. Slide the new power supply into the chassis until the power supply is fully seated and the release latch snaps into place.

NOTE: The systems configured in rack-mode, re-latch the cable management arm if you unlatched it. For information about the cable management arm, see the system's rack documentation.

4. Connect the power cable to the power supply and plug the cable into a power outlet.

CAUTION: When connecting the power cable, secure the cable with the cable strap.

NOTE: When installing, hot-swapping, or hot-adding a new power supply, allow several seconds for the system to recognize the power supply and determine its status. The power-supply status indicator or handle turns green to signify that the power supply is functioning properly.

Removing The Power Supply Blank

CAUTION: To ensure proper system cooling, the power supply blank must be installed in the second power supply bay in a non-redundant configuration. Remove the power supply blank only if you are installing a second power supply.

If you are installing a second power supply, remove the power supply blank in the bay by pulling outward on the blank.

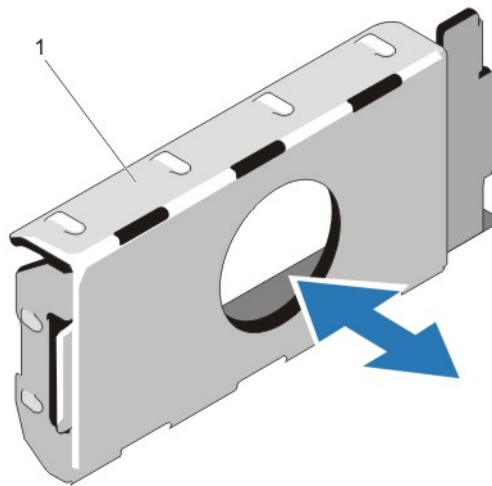

Figure 53. Removing and Installing the Power Supply Blank

1. power supply blank

Installing The Power Supply Blank

NOTE: Install the power supply blank only in the second power supply bay.

To install the power supply blank, align the blank with the power supply bay and insert it into the chassis until it clicks into place.

Replacing The Power Supply Divider

△ CAUTION: Many repairs may only be done by a certified service technician. You should only perform troubleshooting and simple repairs as authorized in your product documentation, or as directed by the online or telephone service and support team. Damage due to servicing that is not authorized by Dell is not covered by your warranty. Read and follow the safety instructions that came with the product.

1. Turn off the system, including any attached peripherals, and disconnect the system from the electrical outlet and peripherals.
2. Remove the redundant power supply module(s) or power supply blank as applicable.
3. Remove the screw securing the power-supply divider to the chassis.
4. Slide out the power-supply divider and rotate clockwise to free the tabs on the power-supply divider from the slots of the power supply unit cage .
5. Slide the power-supply divider out of the chassis.
6. Align the tabs of the new power-supply divider with the slots of the power supply unit cage .
7. Rotate the power-supply divider counter-clockwise and slide it in until the power-supply divider is seated in the slots of the power supply unit cage .
8. Secure the power supply divider to the chassis using the screw.
9. Install the redundant power supply module(s) or power supply blank as applicable.
10. Reconnect the system to its electrical outlet and turn the system on, including any attached peripherals.

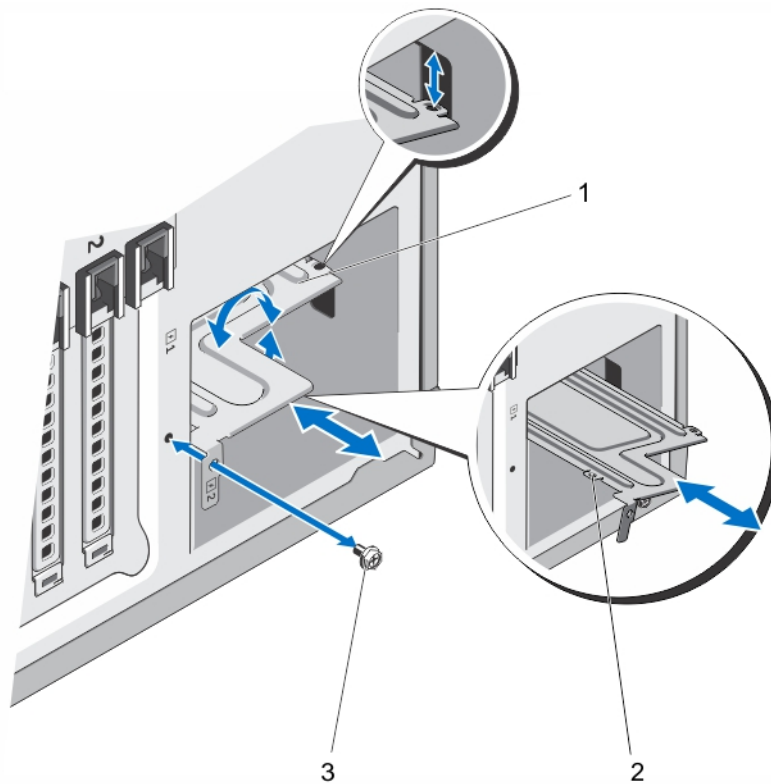



Figure 54. Removing and Installing the Power-Supply Divider

1. power supply divider
2. tabs (4)

3. screw

Non-Redundant AC Power Supply

Your system supports a non-redundant 350 W AC power supply.

-  **NOTE:** Non-redundant power supply is supported in systems with cabled hard drives and systems with an x8 backplane.
-  **NOTE:** When selecting or upgrading your system configuration, verify the system power consumption with the Dell Energy Smart Solution Advisor at dell.com/ESSA to ensure optimum power utilization.

Removing A Non-Redundant AC Power Supply

 **CAUTION:** Many repairs may only be done by a certified service technician. You should only perform troubleshooting and simple repairs as authorized in your product documentation, or as directed by the online or telephone service and support team. Damage due to servicing that is not authorized by Dell is not covered by your warranty. Read and follow the safety instructions that came with the product.

1. Turn off the system, including any attached peripherals, and disconnect the system from the electrical outlet and peripherals.
2. If applicable, rotate the system feet inward and lay the system on its side on a flat, stable surface.
 -  **NOTE:** For systems installed with the wheel assembly, ensure that you lay the system on a sturdy, stable surface with the wheel assembly extending off the edge of the surface.
3. Disconnect the power cable from the power source.
4. Disconnect the power cable from the power supply and remove the power cables from the cable strap.
5. Open the system.
6. Disconnect all the power cables from the power supply to the system board, hard-drive backplane, hard drives, and optical drives, as applicable.
7. Remove the screw securing the power supply to the chassis and slide the power supply out of the power supply unit cage.

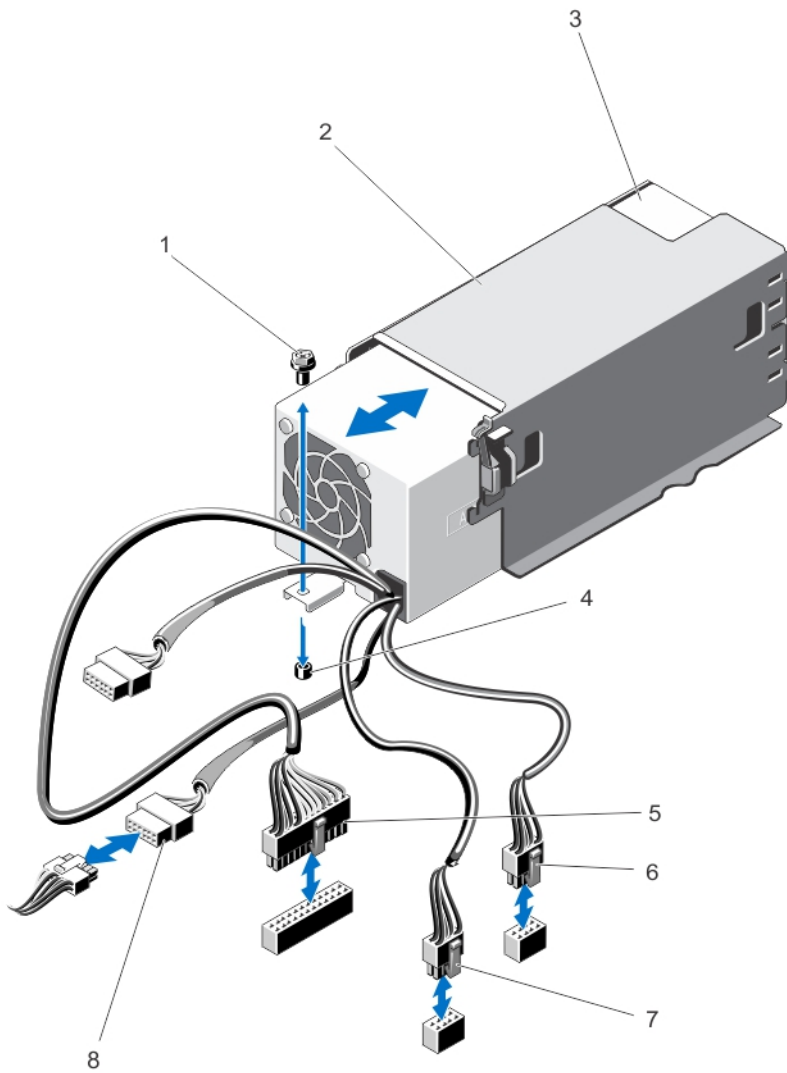



Figure 55. Removing and Installing a Non-Redundant AC Power Supply

- | | |
|-------------------------------|------------------------|
| 1. screw | 6. P2 cable connector |
| 2. power supply unit cage | 7. P3 cable connector |
| 3. non-redundant power supply | 8. backplane connector |
| 4. standoff on the chassis | |
| 5. P1 cable connector | |

Installing A Non-Redundant AC Power Supply

 **CAUTION:** Many repairs may only be done by a certified service technician. You should only perform troubleshooting and simple repairs as authorized in your product documentation, or as directed by the online or telephone service and support team. Damage due to servicing that is not authorized by Dell is not covered by your warranty. Read and follow the safety instructions that came with the product.

1. Unpack the new power supply.
2. Open the system.
3. Slide the new power supply into the power supply unit cage until the power supply is fully seated.
4. Tighten the screw to secure the power supply to the chassis.
5. Connect all the power cables to the system board, hard-drive backplane, hard drives, and optical drives, as applicable.
6. Close the system.
7. If applicable, place the system upright on a flat, stable surface and rotate the system feet outward.
8. Reconnect the system to its electrical outlet and turn the system on, including any attached peripherals.

Power Distribution Board And Power Interposer Board

The power distribution board and the power interposer board are only supported in systems with redundant power supplies.

 **NOTE:** The power distribution board is installed on the power interposer board and then installed into the system.

Removing The Power Interposer Board

 **CAUTION:** Many repairs may only be done by a certified service technician. You should only perform troubleshooting and simple repairs as authorized in your product documentation, or as directed by the online or telephone service and support team. Damage due to servicing that is not authorized by Dell is not covered by your warranty. Read and follow the safety instructions that came with the product.

1. Turn off the system, including any attached peripherals, and disconnect the system from the electrical outlet and peripherals.

 **CAUTION:** To prevent damage to the power interposer board, you must remove the power supply module(s) or power supply blank from the system before removing the power interposer board or power distribution board.

2. Remove the power supply module(s) or power supply blank from the back of the chassis.
3. If applicable, rotate the system feet inward and lay the system on its side on a flat, stable surface.

 **NOTE:** For systems installed with the wheel assembly, ensure that you lay the system on a sturdy, stable surface with the wheel assembly extending off the edge of the surface.

4. Open the system.
5. Disconnect the power cables from the hard-drive backplane and the system board.

 **NOTE:** If applicable, remove the expansion card to enable removing the P3 power cable from the system board.

6. Remove the four screws securing the power distribution board to the chassis.
7. Press the release latch on the power interposer board to release the power interposer board from the hooks on the power supply unit cage.
8. Lift the power interposer board along with the power distribution board up and out of the chassis.

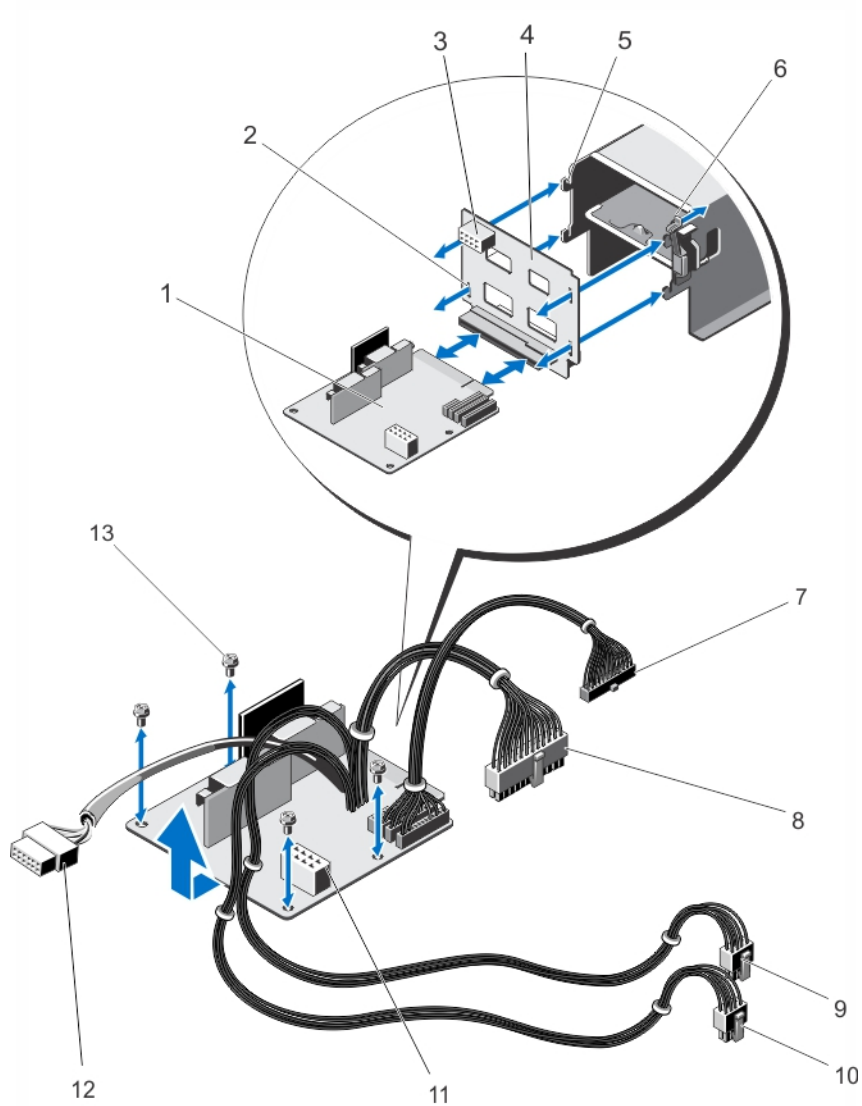



Figure 56. Removing and Installing the Power Interposer Board and the Power Distribution Board

- | | |
|--|-------------------------|
| 1. power distribution board | 8. P1 cable connector |
| 2. slots on power interposer board (4) | 9. P2 cable connector |
| 3. GPU power connector | 10. P3 cable connector |
| 4. power interposer board | 11. GPU power connector |
| 5. hooks (4) | 12. backplane connector |
| 6. release latch | 13. screws (4) |
| 7. P6 cable connector | |

Installing The Power Interposer Board

 **CAUTION:** Many repairs may only be done by a certified service technician. You should only perform troubleshooting and simple repairs as authorized in your product documentation, or as directed by the online or telephone service and support team. Damage due to servicing that is not authorized by Dell is not covered by your warranty. Read and follow the safety instructions that came with the product.

1. If applicable, install the power distribution board onto the power interposer board.
2. Align the power interposer board with the hooks on the power supply cage and slide it into place.
3. Install the four screws that secure the power distribution board to the chassis.
4. Route the power cables through the securing clips as applicable, and connect the power cables to the system board.
5. Route the P3 power cable through the securing clip on the system board and connect power cable to the hard-drive backplane.
6. Install the power supply module(s) or power supply blank in their original locations.
7. Close the system.
8. If applicable, place the system upright on a flat, stable surface and rotate the system feet outward.
9. Reconnect the system to its electrical outlet and turn the system on, including any attached peripherals.

Replacing The Power Distribution Board

 **CAUTION:** Many repairs may only be done by a certified service technician. You should only perform troubleshooting and simple repairs as authorized in your product documentation, or as directed by the online or telephone service and support team. Damage due to servicing that is not authorized by Dell is not covered by your warranty. Read and follow the safety instructions that came with the product.

1. Remove the power interposer board and the power distribution board together from the system.
2. Slide out the power distribution board from the power interposer board and replace with the new power distribution board.
3. Install the power interposer board and the power distribution board together in the system.

System Battery

Replacing The System Battery

 **WARNING:** There is a danger of a new battery exploding if it is incorrectly installed. Replace the battery only with the same or equivalent type recommended by the manufacturer. See your safety information for additional information.

 **CAUTION:** Many repairs may only be done by a certified service technician. You should only perform troubleshooting and simple repairs as authorized in your product documentation, or as directed by the online or telephone service and support team. Damage due to servicing that is not authorized by Dell is not covered by your warranty. Read and follow the safety instructions that came with the product.

1. Turn off the system, including any attached peripherals, and disconnect the system from the electrical outlet and peripherals.
2. If applicable, rotate the system feet inward and lay the system on its side on a flat, stable surface.

 **NOTE:** For systems installed with the wheel assembly, ensure that you lay the system on a sturdy, stable surface with the wheel assembly extending off the edge of the surface.

3. Open the system.
4. Locate the battery socket.

 **CAUTION:** To avoid damage to the battery connector, you must firmly support the connector while installing or removing a battery.

5. To remove the battery, support the battery connector by pressing down firmly on the positive side of the connector.

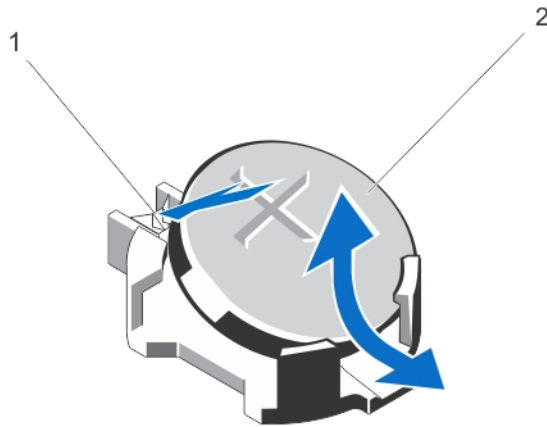

Figure 57. Removing and Installing the System Battery

1. positive side of battery connector
2. system battery
6. Lift the battery out of the securing tabs at the negative side of the connector.
7. To install a new system battery, support the battery connector by pressing down firmly on the positive side of the connector.
8. Hold the battery with the "+" facing up and slide it under the securing tabs at the positive side of the connector.
9. Press the battery straight down into the connector until it snaps into place.
10. Install the cooling shroud.
11. Close the system.
12. If applicable, place the system upright on a flat, stable surface and turn the system feet outward.
13. Reconnect the system to the electrical outlet and turn the system on, including any attached peripherals.
14. Enter the System Setup to confirm that the battery is operating properly.
15. Enter the correct time and date in the System Setup **Time** and **Date** fields.
16. Exit the System Setup.

Control-Panel Assembly

The control-panel assembly consists of the following:

- Control-panel board
- Control panel with LCD module or diagnostic indicators
- VGA module (For systems in rack mode only)

The control-panel assembly with diagnostic indicators is supported on systems with cabled hard drives and systems with an x8 backplane. The control-panel assembly with LCD module is supported on systems with hot-swappable hard drives only.

Removing The Control-Panel Assembly

⚠ CAUTION: Many repairs may only be done by a certified service technician. You should only perform troubleshooting and simple repairs as authorized in your product documentation, or as directed by the online or telephone service and support team. Damage due to servicing that is not authorized by Dell is not covered by your warranty. Read and follow the safety instructions that came with the product.

1. If installed, remove the front bezel.
2. Turn off the system, including any attached peripherals, and disconnect the system from the electrical outlet and peripherals.
3. Open the system.
4. Remove the screw on the side of the chassis that secures the control-panel assembly to the chassis.
5. Slide the control-panel assembly out of the chassis.

⚠ CAUTION: Do not use excessive force when removing the control panel cable as it can damage the connectors.

6. Remove the control panel cable and if applicable, the VGA module cable from the control-panel assembly.

🔧 NOTE: Ensure that the control panel cable and if applicable, the VGA module cable, does not slip back into the chassis.

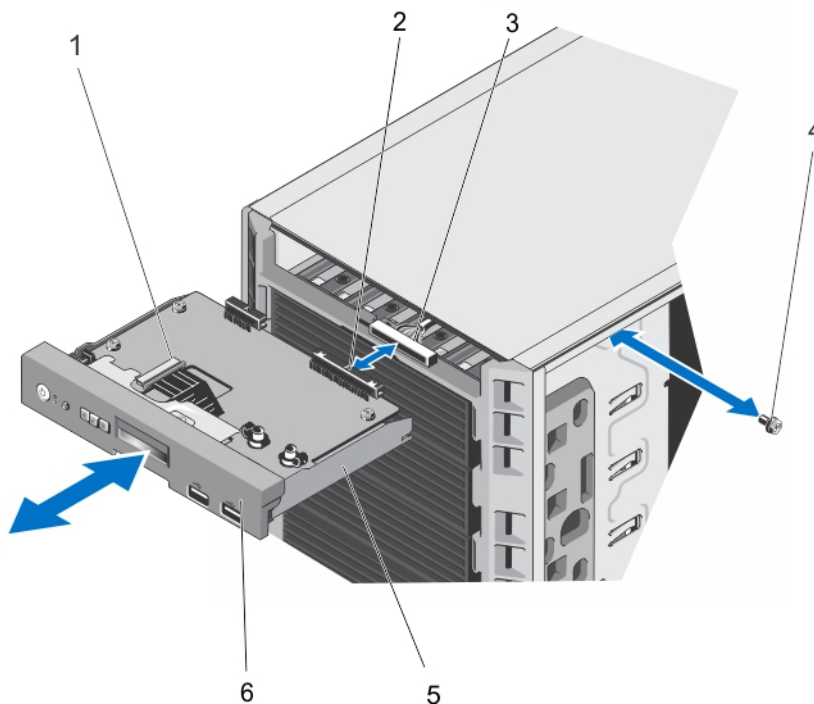

Figure 58. Removing and Installing the Control-Panel assembly With an LCD Module in a Tower-Mode System

1. LCD module ZIF connector
2. control-panel assembly connector

- 3. control-panel assembly cable connector
- 4. screw
- 5. control-panel assembly
- 6. control panel

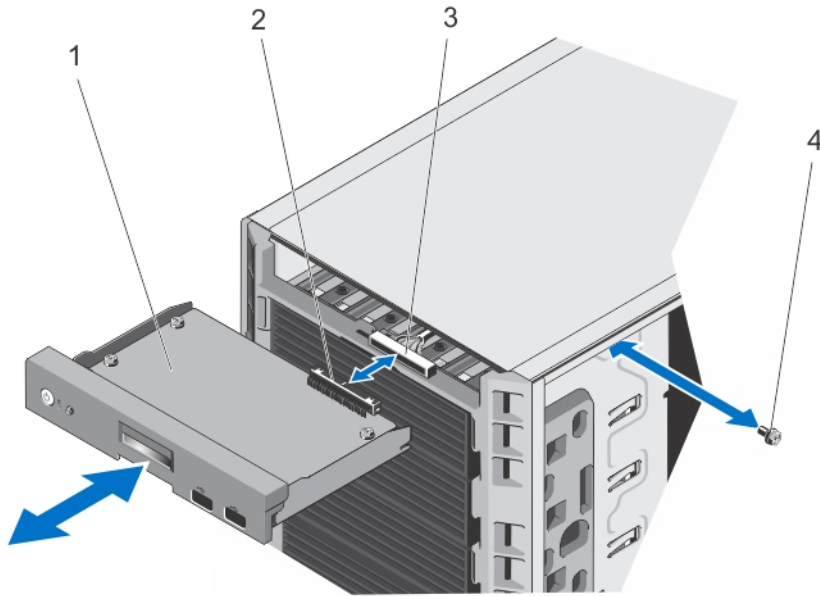

Figure 59. Removing and Installing the Control-Panel Assembly With Diagnostic Indicators in a Tower-Mode System

- 1. control panel board
- 2. control-panel assembly connector
- 3. control-panel assembly cable connector
- 4. screw

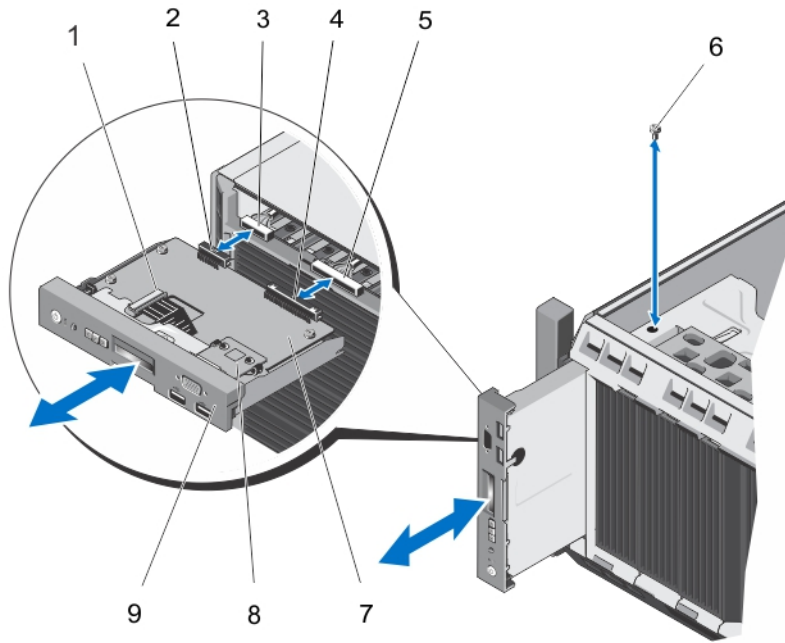



Figure 60. Removing and Installing the Control-Panel Assembly in a Rack-Mode System

- | | |
|---|--------------------------------|
| 1. LCD module ZIF connector | 6. screw |
| 2. VGA module connector | 7. control-panel board |
| 3. VGA module cable connector | 8. VGA module |
| 4. control-panel assembly connector | 9. control panel for rack mode |
| 5. control-panel assembly cable connector | |

7. If you are replacing the control-panel assembly, remove the information tag by following the steps below:
- Locate the tabs on the information tag.
 - Use a flat screwdriver to press the tabs on the tag one at a time.
 - Pull the information tag out of the slot to remove it from the control-panel assembly.

 **NOTE:** Retain the information tag for replacement in the new control-panel assembly.

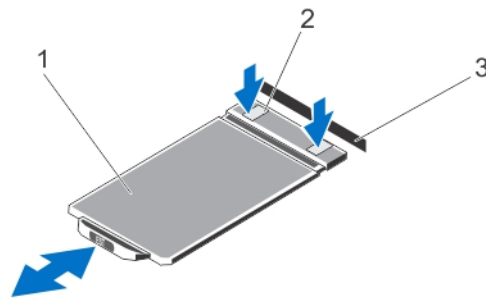





Figure 61. Removing and Installing the Information Tag

- information tag
- tabs (2)

3. slot

Installing The Control-Panel Assembly

 **CAUTION:** Many repairs may only be done by a certified service technician. You should only perform troubleshooting and simple repairs as authorized in your product documentation, or as directed by the online or telephone service and support team. Damage due to servicing that is not authorized by Dell is not covered by your warranty. Read and follow the safety instructions that came with the product.

1. Connect the control panel cable and if applicable, the VGA module cable to the control-panel assembly.
2. Align and insert the control-panel assembly into the slot in the chassis.
 -  **NOTE:** Ensure that you do not crimp the cables as you insert the control-panel assembly into the slot.
3. Push the control-panel assembly so that it is flush with the back of the slot in the chassis.
4. Secure the control-panel assembly to the chassis using the screw on the side of the chassis.
5. Replace the blank information tag in the new control panel with the information tag retained from the old control panel.
 -  **NOTE:** Information tag lists system information such as Service Tag, NIC, MAC address, and so on.
6. Close the system.
7. Reconnect the system to its electrical outlet and turn the system on, including any attached peripherals.
8. If applicable, install the front bezel.

Removing The Control Panel

1. If installed, remove the front bezel.
2. Turn off the system, including any attached peripherals, and disconnect the system from the electrical outlet and peripherals.
3. Offset the control panel from the control-panel assembly.
4. Slide the control panel out of the control-panel assembly.

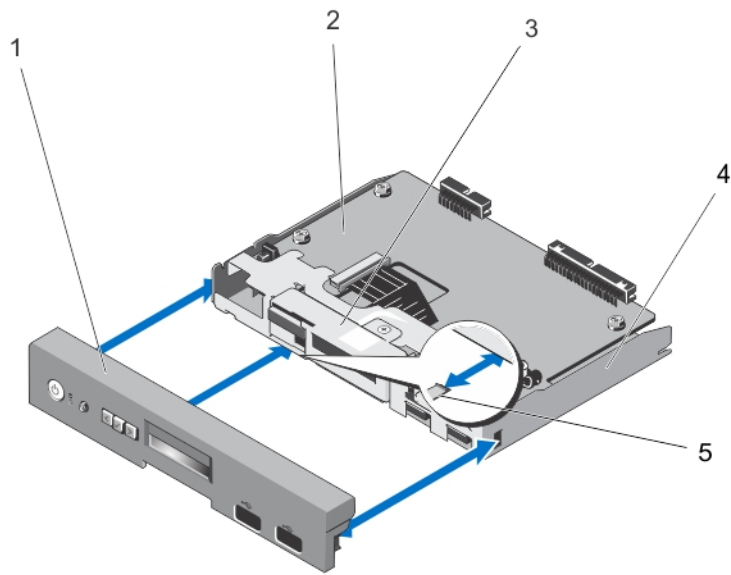

Figure 62. Removing and Installing the Control Panel for Systems With an LCD Module

- | | |
|------------------------|---------------------------|
| 1. control panel | 4. control-panel assembly |
| 2. control-panel board | 5. tabs (3) |
| 3. LCD module | |

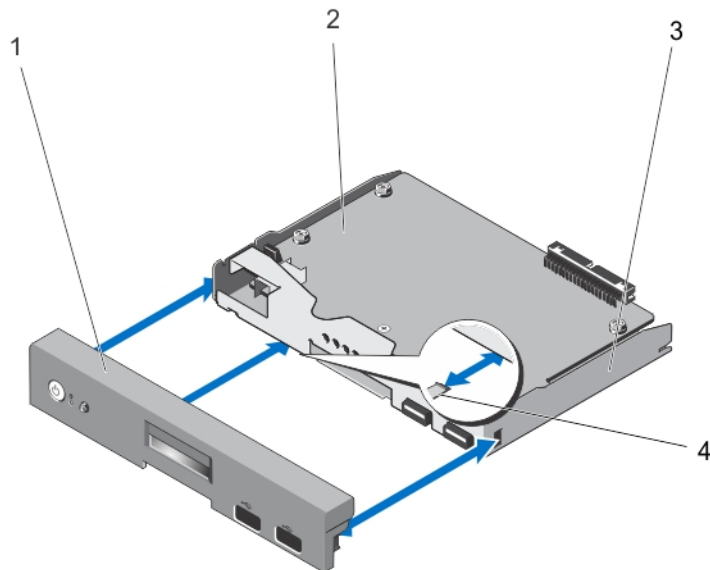



Figure 63. Removing and Installing the Control Panel for Systems With Diagnostic Indicators

- | |
|------------------------|
| 1. control panel |
| 2. control-panel board |

3. control-panel assembly
4. tabs (3)

Installing The Control Panel

 **CAUTION:** Many repairs may only be done by a certified service technician. You should only perform troubleshooting and simple repairs as authorized in your product documentation, or as directed by the online or telephone service and support team. Damage due to servicing that is not authorized by Dell is not covered by your warranty. Read and follow the safety instructions that came with the product.

1. Align the three tabs on the inside of the control panel with the slots on the control-panel assembly.
2. Slide the control panel into the control-panel assembly until it locks into place.
3. Reconnect the system to its electrical outlet and turn the system on, including any attached peripherals.
4. If applicable, install the front bezel.

Removing The Control-Panel Board For Systems With LCD Modules

 **CAUTION:** Many repairs may only be done by a certified service technician. You should only perform troubleshooting and simple repairs as authorized in your product documentation, or as directed by the online or telephone service and support team. Damage due to servicing that is not authorized by Dell is not covered by your warranty. Read and follow the safety instructions that came with the product.

1. If installed, remove the front bezel.
2. Turn off the system, including any attached peripherals, and disconnect the system from the electrical outlet and peripherals.
3. Open the system.
4. Remove the control-panel assembly.
5. Remove the three screws securing the control-panel board to the control-panel assembly.
6. Remove the LCD ZIF cable from the LCD module ZIF connector on the control-panel board.

 **NOTE:** The LCD module connector is a ZIF (zero insertion force) connector. Ensure that the locking tab on the connector is released before removal and insertion. The locking tab must be engaged after insertion.

7. Lift the control-panel board away from the control-panel assembly.
8. If you are replacing the control-panel board in a system in rack mode, remove the VGA module from the control-panel board.

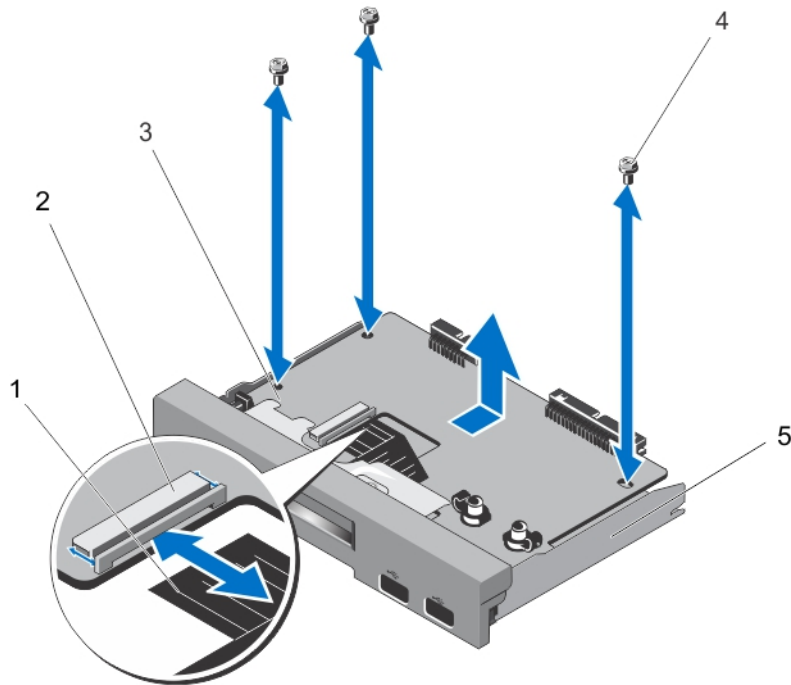

Figure 64. Removing and Installing the Control-Panel Board With LCD Module

- | | |
|-----------------------------|---------------------------|
| 1. LCD ZIF cable | 4. screws (3) |
| 2. LCD module ZIF connector | 5. control-panel assembly |
| 3. control-panel board | |

Installing The Control-Panel Board For Systems With LCD Modules

⚠ CAUTION: Many repairs may only be done by a certified service technician. You should only perform troubleshooting and simple repairs as authorized in your product documentation, or as directed by the online or telephone service and support team. Damage due to servicing that is not authorized by Dell is not covered by your warranty. Read and follow the safety instructions that came with the product.

1. Using the screw holes, align the control-panel board with the control-panel assembly.
2. Secure the control-panel board to the control-panel assembly using the three screws.
3. Connect the LCD ZIF cable to the LCD module ZIF connector on the control-panel board.
 - 🔧 NOTE:** The LCD module connector is a ZIF (zero insertion force) connector. Ensure that the locking tab on the connector is released before removal and insertion. The locking tab must be engaged after insertion.
4. If you are replacing the control-panel board in a system in rack mode, install the VGA module on the control-panel board.
5. Install the control-panel assembly in the chassis.
6. Close the system.
7. Reconnect the system to its electrical outlet and turn the system on, including any attached peripherals.
8. If applicable, install the front bezel.

Removing The Control-Panel Board For Systems With Diagnostic Indicators

CAUTION: Many repairs may only be done by a certified service technician. You should only perform troubleshooting and simple repairs as authorized in your product documentation, or as directed by the online or telephone service and support team. Damage due to servicing that is not authorized by Dell is not covered by your warranty. Read and follow the safety instructions that came with the product.

NOTE: The control-panel assembly with diagnostic indicators is supported on systems with cabled hard drives and systems with an x8 backplane.

1. If installed, remove the front bezel.
2. Turn off the system, including any attached peripherals, and disconnect the system from the electrical outlet and peripherals.
3. Open the system.
4. Remove the control-panel assembly.
5. Remove the three screws securing the control-panel board to the control-panel assembly.
6. Lift the control-panel board away from the control-panel assembly.

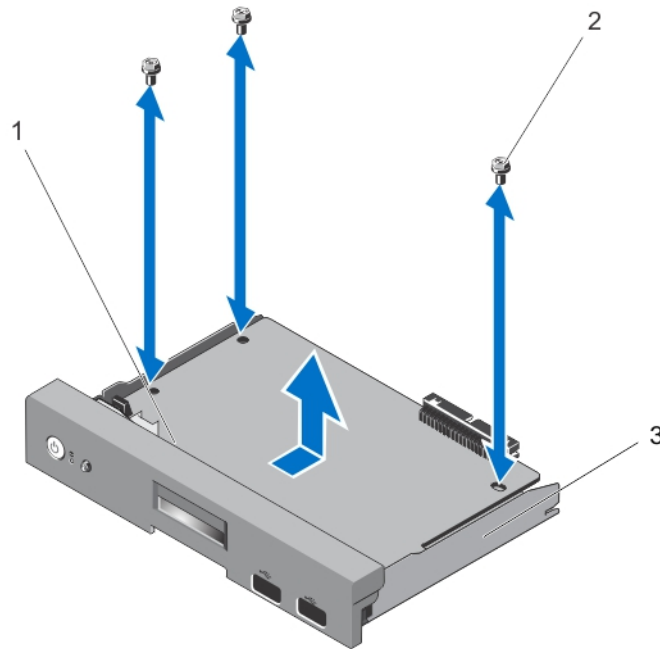



Figure 65. Removing and Installing the Control-Panel Board With Diagnostic Indicators

1. control-panel board
2. screws (3)
3. control-panel assembly

Installing The Control-Panel Board For Systems With Diagnostic Indicators

 **CAUTION:** Many repairs may only be done by a certified service technician. You should only perform troubleshooting and simple repairs as authorized in your product documentation, or as directed by the online or telephone service and support team. Damage due to servicing that is not authorized by Dell is not covered by your warranty. Read and follow the safety instructions that came with the product.

 **NOTE:** The control-panel assembly with diagnostic indicators is supported on systems with cabled hard drives and systems with an x8 backplane.

1. Using the screw holes, align the control-panel board with the control-panel assembly.
2. Secure the control-panel board to the control-panel assembly using the three screws.
3. Install the control-panel assembly in the chassis.
4. Close the system.
5. Reconnect the system to its electrical outlet and turn the system on, including any attached peripherals.
6. If applicable, install the front bezel.

Removing The LCD Module

 **CAUTION:** Many repairs may only be done by a certified service technician. You should only perform troubleshooting and simple repairs as authorized in your product documentation, or as directed by the online or telephone service and support team. Damage due to servicing that is not authorized by Dell is not covered by your warranty. Read and follow the safety instructions that came with the product.

1. If installed, remove the front bezel.
2. Turn off the system, including any attached peripherals, and disconnect the system from the electrical outlet and peripherals.
3. Open the system.
4. Remove the control-panel assembly.
5. Remove the control panel from the control-panel assembly.
6. Remove the LCD ZIF cable from the LCD module ZIF connector on the control-panel board.

 **NOTE:** The LCD module connector is a ZIF (zero insertion force) connector. Ensure that the locking tab on the connector is released before removal and insertion. The locking tab must be engaged after insertion.

7. Remove the screw connecting the LCD module to the control-panel assembly and slide out the LCD module.

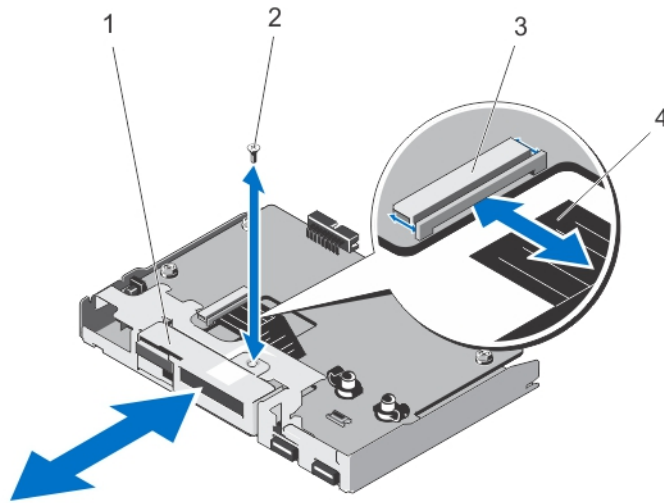

Figure 66. Removing and Installing the LCD Module

1. LCD module
2. screw
3. LCD module ZIF connector
4. LCD ZIF cable

Installing The LCD Module

CAUTION: Many repairs may only be done by a certified service technician. You should only perform troubleshooting and simple repairs as authorized in your product documentation, or as directed by the online or telephone service and support team. Damage due to servicing that is not authorized by Dell is not covered by your warranty. Read and follow the safety instructions that came with the product.

1. Align and insert the LCD module with the LCD module slot on the control-panel assembly.
2. Secure the LCD module into the control-panel assembly using the screw.
3. Connect the LCD ZIF cable to the LCD module ZIF connector on the control-panel board.
NOTE: The LCD module connector is a ZIF (zero insertion force) connector. Ensure that the locking tab on the connector is released before removal and insertion. The locking tab must be engaged after insertion.
4. Install the control-panel board on the control-panel assembly.
5. Install the control-panel assembly into the chassis.
6. Reconnect the system to its electrical outlet and turn the system on, including any attached peripherals.
7. If applicable, install the front bezel.

Removing The VGA Module—Rack Mode

△ CAUTION: Many repairs may only be done by a certified service technician. You should only perform troubleshooting and simple repairs as authorized in your product documentation, or as directed by the online or telephone service and support team. Damage due to servicing that is not authorized by Dell is not covered by your warranty. Read and follow the safety instructions that came with the product.

1. If installed, remove the front bezel.
2. Turn off the system, including any attached peripherals, and disconnect the system from the electrical outlet and peripherals.
3. Open the system.
4. Remove the control panel assembly.
5. Lift the VGA module from the securing tabs on the control-panel board.
6. Remove the VGA cable from the control-panel assembly.

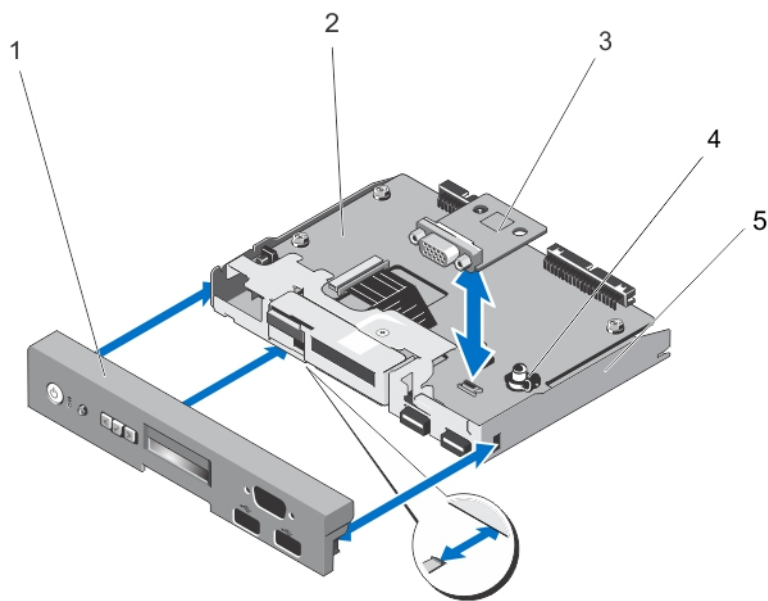



Figure 67. Removing and Installing the VGA Module

- | | |
|------------------------|---------------------------|
| 1. control panel | 4. securing tabs (2) |
| 2. control-panel board | 5. control-panel assembly |
| 3. VGA module | |

Installing The VGA Module—Rack Mode

 **CAUTION:** Many repairs may only be done by a certified service technician. You should only perform troubleshooting and simple repairs as authorized in your product documentation, or as directed by the online or telephone service and support team. Damage due to servicing that is not authorized by Dell is not covered by your warranty. Read and follow the safety instructions that came with the product.

1. Align the VGA module with the securing tabs on the control-panel board.
2. Install the VGA module by pressing down the VGA module until it is fully seated in the securing tabs.
3. Connect the VGA cable to the control-panel assembly.
4. Install the control panel for rack mode in the control-panel assembly.
5. Install the control-panel assembly.
6. Reconnect the system to its electrical outlet and turn the system on, including any attached peripherals.
7. If applicable, install the front bezel.

System Board

Removing The System Board

 **CAUTION:** Many repairs may only be done by a certified service technician. You should only perform troubleshooting and simple repairs as authorized in your product documentation, or as directed by the online or telephone service and support team. Damage due to servicing that is not authorized by Dell is not covered by your warranty. Read and follow the safety instructions that came with the product.

 **CAUTION:** If you are using the Trusted Program Module (TPM) with an encryption key, you may be prompted to create a recovery key during program or system setup. Be sure to create and safely store this recovery key. If you replace this system board, you must supply the recovery key when you restart your system or program before you can access the encrypted data on your hard drives.

1. Turn off the system, including any attached peripherals, and disconnect the system from the electrical outlet and peripherals.
2. If applicable, rotate the system feet inward and lay the system on its side on a flat, stable surface.

 **NOTE:** For systems installed with the wheel assembly, ensure that you lay the system on a sturdy, stable surface with the wheel assembly extending off the edge of the surface.

3. Open the system.
4. Remove the following as applicable:
 - a) cooling shroud
 - b) system cooling fan
 - c) PCIe card holder
 - d) iDRAC ports card
 - e) all expansion cards

 **WARNING:** The heat sink and processor are hot to the touch for some time after the system has been powered down. Allow the heat sink and processor to cool before handling them.

- f) heat sink and processor
- g) memory modules
- h) internal dual SD module
- i) internal USB key

5. Disconnect all cables from the system board.

CAUTION: Take care not to damage the system identification button while removing the system board from the chassis.

6. Remove the 11 screws that secure the system board to the chassis.

7. Grasp the system-board holders and slide the system board towards the front of the system.

CAUTION: Do not lift the system board assembly by grasping a memory module, processor, or other components.

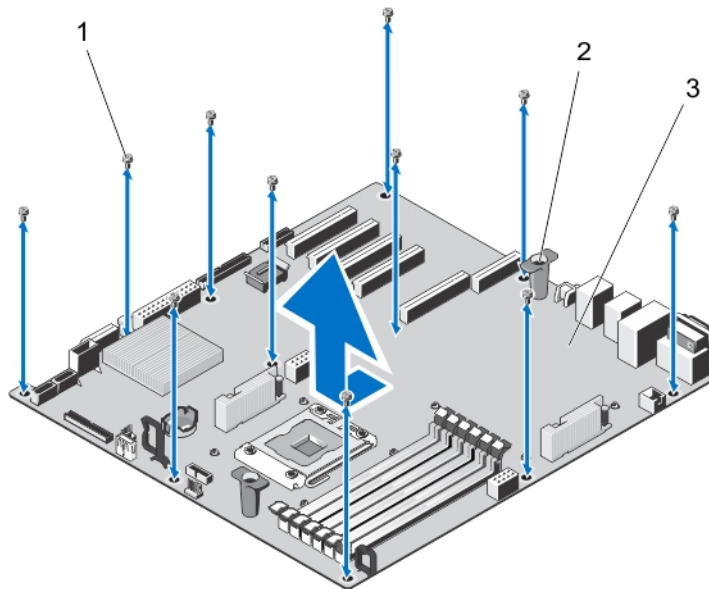



Figure 68. Removing the System Board

1. screws (11)
2. system-board holders (2)
3. system board

Installing The System Board

CAUTION: Many repairs may only be done by a certified service technician. You should only perform troubleshooting and simple repairs as authorized in your product documentation, or as directed by the online or telephone service and support team. Damage due to servicing that is not authorized by Dell is not covered by your warranty. Read and follow the safety instructions that came with the product.

 **CAUTION:** If you are using the Trusted Program Module (TPM) with an encryption key, you may be prompted to create a recovery key during program or system setup. Be sure to create and safely store this recovery key. If you replace this system board, you must supply the recovery key when you restart your system or program before you can access the encrypted data on your hard drives.

1. Unpack the new system board assembly.

 **CAUTION:** Do not lift the system board assembly by grasping a memory module, processor, or other components.

2. Using the system-board holders, lower the system board into the chassis while aligning the guiding slot on the system board with the tab in the chassis.

 **NOTE:** The guiding slot on the system board is located on the edge of the system board and near the memory modules.

3. Push the system board towards the back of the chassis until the system board clicks into place.

4. Secure the system board to the chassis using the eleven screws.

 **NOTE:** It is recommended that you install screws from diagonally opposite corners.

5. Install the following, as applicable:

- a) heat sink and processor
- b) memory modules
- c) internal dual SD module
- d) internal USB key
- e) expansion cards
- f) iDRAC ports card
- g) PCIe card holder
- h) system cooling fan
- i) cooling shroud

6. Reconnect all cables to the system board.

7. Close the system.

8. If applicable, place the system upright on a flat, stable surface and rotate the system feet outward.

9. Reconnect the system to its electrical outlet and turn the system on, including any attached peripherals.

10. Import your new or existing iDRAC Enterprise license. For more information, see *iDRAC7 User's Guide*, at dell.com/support/manuals.

Converting The System From Tower Mode To Rack Mode

 **CAUTION:** Many repairs may only be done by a certified service technician. You should only perform troubleshooting and simple repairs as authorized in your product documentation, or as directed by the online or telephone service and support team. Damage due to servicing that is not authorized by Dell is not covered by your warranty. Read and follow the safety instructions that came with the product.

 **NOTE:** Only systems with hot-swappable hard drives are rackable.

Safety Instructions

 **NOTE:** For specific caution statements and procedures, see the rack installation documentation that shipped with your system and the rack kit. For complete safety and regulatory information, see the safety instructions that shipped with your system.

Observe the following precautions for stability and safety of the system in rack mode:

- Your rack kit has been approved only for the rack cabinet provided. Ensure that installation of the equipment into any other rack complies with all applicable standards. Dell disclaims all liability and warranties with respect to combinations of equipment with any other rack.
- Before installing your equipment in a rack, install all front and side stabilizers. Failure to install stabilizers can allow the rack to tip over.
- Always load from the bottom up, and load the heaviest items first.
- Do not overload the AC power supply branch circuit that provides power to the rack.
- Do not stand or step on any components in the rack.

Preparing A System For Conversion From Tower Mode To Rack Mode

You require the following items to convert your system from tower to rack mode:

- Rack ears (left and right) with three screws each
 - VGA module
 - Control panel for rack mode
 - #2 Phillips screwdriver
1. Turn off the system, including any attached peripherals, and disconnect the system from the electrical outlet and peripherals.
 2. If applicable, rotate the system feet inward and lay the system on its side on a flat, stable surface.
 **NOTE:** For systems installed with the wheel assembly, ensure that you lay the system on a sturdy, stable surface with the wheel assembly extending off the edge of the surface.
 3. If applicable, remove the system feet or wheel assembly.

4. Open the system.
5. Remove the system top cover by following the steps below:
 - a) Using a #2 Phillips screwdriver, remove the three screws on the side of the system that secure the system top cover to the system chassis.
 - b) Slide the top panel toward the back of the system until the panel hooks clear the chassis slots.
 - c) Rotate the free side of the panel outward about 15 degrees and pull the panel clear of the system.

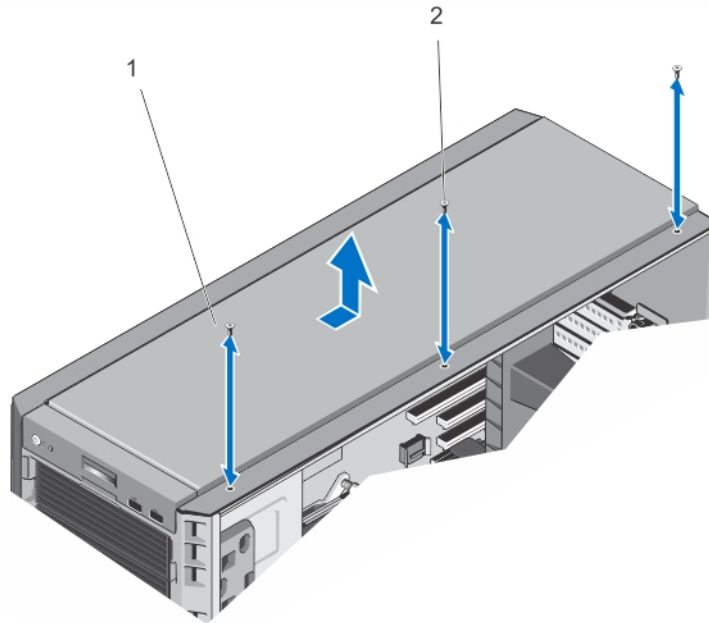

Figure 69. Removing and Installing The System Top Cover

1. system top cover
 2. screws (3)
6. Remove the control panel assembly from the chassis.
 7. Remove the control panel for tower mode from the control panel assembly.
 8. Install the VGA module on the control panel assembly.
 9. Install the control panel for rack mode.
 10. Install the control panel assembly into the chassis.
 11. To attach the rack ears, follow the steps below:
 - a) Align the three screw holes on the right rack ear with the screw holes on the right side of the rack system.
 - b) Install the three screws using a #2 Phillips screwdriver.
 - c) Repeat step a and step b to install the left rack ear.

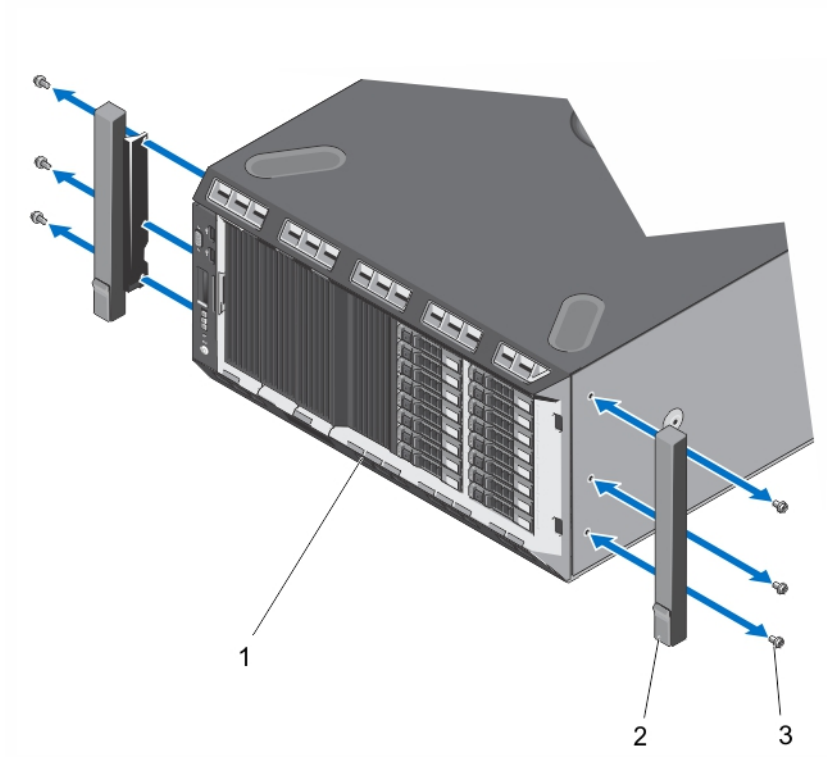

Figure 70. Removing and Installing the Rack Ears

1. front panel
2. rack ears (2)
3. screws for each rack ear (3)

12. Close the system.

Rack Installation

To install the system in a rack, see the system's Rack Installation Guide.

Troubleshooting Your System

Safety First—For You And Your System

 **CAUTION:** Many repairs may only be done by a certified service technician. You should only perform troubleshooting and simple repairs as authorized in your product documentation, or as directed by the online or telephone service and support team. Damage due to servicing that is not authorized by Dell is not covered by your warranty. Read and follow the safety instructions that came with the product.

Troubleshooting System Startup Failure

If you boot the system to the BIOS boot mode after installing an operating system from the UEFI Boot Manager, the system hangs. The reverse is also true. You must boot to the same boot mode in which you installed the operating system.

For all other startup issues, note the system messages that appear on the screen.

Troubleshooting External Connections

Ensure that all external cables are securely attached to the external connectors on your system before troubleshooting any external devices.

Troubleshooting The Video Subsystem

1. Check the system and power connections to the monitor.
2. Check the video interface cabling from the system to the monitor.
3. Run the appropriate diagnostic test.

If the tests run successfully, the problem is not related to video hardware.

If the tests fail, see [Getting Help](#).

Troubleshooting A USB Device

Use the following steps to troubleshoot a USB keyboard/mouse. For other USB devices, go to step 7.

1. Disconnect the keyboard and mouse cables from the system briefly and reconnect them.
2. Connect the keyboard/mouse to the USB port(s) on the opposite side of the system.
3. If the problem is resolved, restart the system, enter the System Setup, and check if the non-functioning USB ports are enabled.
4. Replace the keyboard/mouse with another working keyboard/mouse.
5. If the problem is resolved, replace the faulty keyboard/mouse.
6. If the problem is not resolved, proceed to the next step to begin troubleshooting the other USB devices attached to the system.

7. Power down all attached USB devices and disconnect them from the system.
8. Restart the system and, if your keyboard is functioning, enter the System Setup. Verify that all USB ports are enabled on the **Integrated Devices** screen, in the System Setup options.
If your keyboard is not functioning, you can also use remote access. If the system is not accessible, reset the NVRAM_CLR jumper inside your system and restore the BIOS to the default settings.
9. Reconnect and power on each USB device one at a time.
10. If a device causes the same problem, power down the device, replace the USB cable with a known good cable, and power up the device.

If all troubleshooting fails, see [Getting Help](#).

Troubleshooting A Serial I/O Device

1. Turn off the system and any peripheral devices connected to the serial port.
2. Swap the serial interface cable with a working cable, and turn on the system and the serial device.
If the problem is resolved, replace the interface cable with a known good cable.
3. Turn off the system and the serial device, and swap the device with a comparable device.
4. Turn on the system and the serial device.

If the problem persists, see [Getting Help](#).

Troubleshooting A NIC

1. Run the appropriate diagnostic test. See Using System Diagnostics for available diagnostic tests.
2. Restart the system and check for any system messages pertaining to the NIC controller.
3. Check the appropriate indicator on the NIC connector:
 - If the link indicator does not light, check all cable connections.
 - If the activity indicator does not light, the network driver files might be damaged or missing. Remove and reinstall the drivers if applicable. See the NIC's documentation.
 - If applicable, change the autonegotiation setting.
 - Use another connector on the switch or hub.
4. Ensure that the appropriate drivers are installed and the protocols are bound. See the NIC's documentation.
5. Enter the System Setup and confirm that the NIC ports are enabled on the **Integrated Devices** screen.
6. Ensure that the NICs, hubs, and switches on the network are all set to the same data transmission speed and duplex. See the documentation for each network device.
7. Ensure that all network cables are of the proper type and do not exceed the maximum length.

If all troubleshooting fails, see [Getting Help](#).

Troubleshooting A Wet System

 **CAUTION:** Many repairs may only be done by a certified service technician. You should only perform troubleshooting and simple repairs as authorized in your product documentation, or as directed by the online or telephone service and support team. Damage due to servicing that is not authorized by Dell is not covered by your warranty. Read and follow the safety instructions that came with the product.

1. Turn off the system and attached peripherals, and disconnect the system from the electrical outlet.
2. Open the system.
3. Disassemble components from the system:
 - Hard drives
 - Hard-drive backplane
 - USB memory key
 - Cooling shroud
 - Expansion-card risers (if present)
 - Expansion cards
 - Power supply(s)
 - Cooling fans
 - Processor and heat sink
 - Memory modules
4. Let the system dry thoroughly for at least 24 hours.
5. Reinstall the components you removed in step 3.
6. Close the system.
7. Turn on the system and attached peripherals.
If the system does not start properly, see [Getting Help](#).
8. If the system starts properly, shut down the system and reinstall all of the expansion cards that you removed.
9. Run the appropriate diagnostic test. For more information, see [Using System Diagnostics](#).

If the tests fail, see [Getting Help](#).

Troubleshooting A Damaged System

 **CAUTION:** Many repairs may only be done by a certified service technician. You should only perform troubleshooting and simple repairs as authorized in your product documentation, or as directed by the online or telephone service and support team. Damage due to servicing that is not authorized by Dell is not covered by your warranty. Read and follow the safety instructions that came with the product.

1. Turn off the system and attached peripherals, and disconnect the system from the electrical outlet.
2. Open the system.
3. Ensure that the following components are properly installed:
 - Cooling shroud
 - Expansion-card risers (if present)
 - Expansion cards
 - Power supply(s)
 - Cooling fans

- Processor and heatsink
 - Memory modules
 - Hard-drive carriers
 - Hard-drive backplane
4. Ensure that all cables are properly connected.
 5. Close the system.
 6. Run the appropriate diagnostic test. For more information, see Using System Diagnostics.

If the tests fail, see [Getting Help](#).

Troubleshooting The System Battery

 **CAUTION:** Many repairs may only be done by a certified service technician. You should only perform troubleshooting and simple repairs as authorized in your product documentation, or as directed by the online or telephone service and support team. Damage due to servicing that is not authorized by Dell is not covered by your warranty. Read and follow the safety instructions that came with the product.

 **NOTE:** If the system is turned off for long periods of time (for weeks or months), the NVRAM may lose its system configuration information. This situation is caused by a defective battery.

1. Re-enter the time and date in the System Setup.
2. Turn off the system and disconnect it from the electrical outlet for at least one hour.
3. Reconnect the system to the electrical outlet and turn on the system.
4. Enter the System Setup.
If the date and time are not correct in the System Setup, check the SEL for system battery messages.

If the problem is not resolved, see [Getting Help](#).

 **NOTE:** Some software may cause the system time to speed up or slow down. If the system seems to operate normally except for the time kept in the System Setup, the problem may be caused by software rather than by a defective battery.

Troubleshooting A Non-Redundant Power Supply

 **CAUTION:** Many repairs may only be done by a certified service technician. You should only perform troubleshooting and simple repairs as authorized in your product documentation, or as directed by the online or telephone service and support team. Damage due to servicing that is not authorized by Dell is not covered by your warranty. Read and follow the safety instructions that came with the product.

1. Press the self-diagnostic button on the power supply.
2. If the power supply status indicator is not lit, turn off the system and attached peripherals, and disconnect the system from the electrical outlet.
3. Open the system.
4. Reseat the power supply and the cables.
5. Close the system.
6. If the problem persists, see [Getting Help](#).

Troubleshooting Redundant Power Supplies

 **CAUTION:** Many repairs may only be done by a certified service technician. You should only perform troubleshooting and simple repairs as authorized in your product documentation, or as directed by the online or telephone service and support team. Damage due to servicing that is not authorized by Dell is not covered by your warranty. Read and follow the safety instructions that came with the product.

1. Reseat the power supply by removing and reinstalling it.

 **NOTE:** After installing a power supply, allow several seconds for the system to recognize the power supply and to determine if it is working properly.

2. If the problem persists, see [Getting Help](#).

Troubleshooting Cooling Problems

 **CAUTION:** Many repairs may only be done by a certified service technician. You should only perform troubleshooting and simple repairs as authorized in your product documentation, or as directed by the online or telephone service and support team. Damage due to servicing that is not authorized by Dell is not covered by your warranty. Read and follow the safety instructions that came with the product.

Ensure that none of the following conditions exist:

- System cover, cooling shroud, EMI filler panel, memory-module blank, or back-filler bracket is removed.
- Ambient temperature is too high.
- External airflow is obstructed.
- A cooling fan is removed or has failed.
- The expansion card installation guidelines have not been followed.

Troubleshooting Cooling Fans

 **CAUTION:** Many repairs may only be done by a certified service technician. You should only perform troubleshooting and simple repairs as authorized in your product documentation, or as directed by the online or telephone service and support team. Damage due to servicing that is not authorized by Dell is not covered by your warranty. Read and follow the safety instructions that came with the product.

1. Open the system.
2. Reseat the fan or the fan's power cable.
3. If the fan functions properly, close the system.

If the problem persists, see [Getting Help](#).

Troubleshooting System Memory

 **CAUTION:** Many repairs may only be done by a certified service technician. You should only perform troubleshooting and simple repairs as authorized in your product documentation, or as directed by the online or telephone service and support team. Damage due to servicing that is not authorized by Dell is not covered by your warranty. Read and follow the safety instructions that came with the product.

1. If the system is operational, run the appropriate diagnostic test. See Using System Diagnostics for available diagnostic tests.

If diagnostics indicates a fault, follow the corrective actions provided by the diagnostic program.

2. If the system is not operational, turn off the system and attached peripherals, and unplug the system from the power source. Wait at least 10 seconds and then reconnect the system to power.
3. Turn on the system and attached peripherals and note the messages on the screen.
If an error message is displayed indicating a fault with a specific memory module, go to step 12.
4. Enter the System Setup and check the system memory setting. Make any changes to the memory settings, if needed.
If the memory settings match the installed memory but a problem is still indicated, go to step 12.
5. Turn off the system and attached peripherals, and disconnect the system from the electrical outlet.
6. Open the system.
7. Check the memory channels and ensure that they are populated correctly.
8. Reseat the memory modules in their sockets.
9. Close the system.
10. Enter the System Setup and check the system memory setting.
If the problem is not resolved, proceed with the next step.
11. Open the system.
12. If a diagnostic test or error message indicates a specific memory module as faulty, swap or replace the module with a known good memory module.
13. To troubleshoot an unspecified faulty memory module, replace the memory module in the first DIMM socket with a module of the same type and capacity.
If an error message is displayed on the screen, this may indicate a problem with the installed DIMM type(s), incorrect DIMM installation, or defective DIMM(s). Follow the on-screen instructions to resolve the problem. For more information, see [General Memory Module Installation Guidelines](#).
14. Close the system.
15. As the system boots, observe any error message that is displayed and the diagnostic indicators on the front of the system.
16. If the memory problem is still indicated, repeat step 12 through step 15 for each memory module installed.

If the problem persists after all memory modules have been checked, see [Getting Help](#).

Troubleshooting An Internal USB Key





CAUTION: Many repairs may only be done by a certified service technician. You should only perform troubleshooting and simple repairs as authorized in your product documentation, or as directed by the online or telephone service and support team. Damage due to servicing that is not authorized by Dell is not covered by your warranty. Read and follow the safety instructions that came with the product.

1. Enter the System Setup and ensure that the **USB key port** is enabled from the **Integrated Devices** screen.
2. Turn off the system and attached peripherals, and disconnect the system from the electrical outlet.
3. Open the system.
4. Locate the USB key and reseat it.
5. Close the system.
6. Turn on the system and attached peripherals and check if the USB key is functioning.
7. If the problem is not resolved, repeat step 2 and step 3.
8. Insert a different USB key that you know works properly.
9. Close the system.

If the problem is not resolved, see [Getting Help](#).

Troubleshooting An SD Card

 **CAUTION:** Many repairs may only be done by a certified service technician. You should only perform troubleshooting and simple repairs as authorized in your product documentation, or as directed by the online or telephone service and support team. Damage due to servicing that is not authorized by Dell is not covered by your warranty. Read and follow the safety instructions that came with the product.

 **NOTE:** Certain SD cards have a physical write-protect switch on the card. If the write-protect switch is turned on then the SD card is not writeable.

1. Enter the System Setup and ensure that the **Internal SD Card Port** is enabled.
2. Turn off the system, including any attached peripherals, and disconnect the system from the electrical outlet.
3. Open the system.

 **CAUTION:** If the **Internal SD Card Redundancy** option is set to **Mirror Mode** in the **Integrated Devices** screen of the **System Setup**, you must follow the instructions in **step 4** through **step 7** to avoid loss of data.

 **NOTE:** When an SD card failure occurs, the internal dual SD module controller notifies the system. On the next reboot, the system displays a message indicating the failure.

4. If the **Internal SD Card Redundancy** option is set to **Disabled**, replace the failed SD card with a new SD card.
5. If SD card 1 has failed, remove the card from SD card slot 1. If SD card 2 has failed, install a new SD card in SD card slot 2 and proceed to step 7.
6. Remove the card present in SD card slot 2 and insert it into SD card slot 1.
7. Insert the new SD card into SD card slot 2.
8. Close the system.
9. Reconnect the system to its electrical outlet and turn the system on, including any attached peripherals.
10. Enter the System Setup and ensure that the **Internal SD Card Port** and **Internal SD Card Redundancy** mode is enabled.
11. Check if the SD card is functioning properly.

If the problem persists, see [Getting Help](#).

Troubleshooting An Optical Or Tape Drive

 **CAUTION:** Many repairs may only be done by a certified service technician. You should only perform troubleshooting and simple repairs as authorized in your product documentation, or as directed by the online or telephone service and support team. Damage due to servicing that is not authorized by Dell is not covered by your warranty. Read and follow the safety instructions that came with the product.

1. Try using a different CD or DVD.
2. Enter the System Setup and ensure that the integrated SATA controller and the drive's SATA port are enabled.
3. Run the appropriate diagnostic test.
4. Turn off the system and attached peripherals, and disconnect the system from the electrical outlet.
5. Open the system.
6. Remove the front bezel.
7. Ensure that the interface cable is securely connected to the drive and to the controller.
8. Ensure that a power cable is properly connected to the drive.
9. Close the system.

If the problem is not resolved, see [Getting Help](#).

Troubleshooting A Hard Drive

 **CAUTION:** Many repairs may only be done by a certified service technician. You should only perform troubleshooting and simple repairs as authorized in your product documentation, or as directed by the online or telephone service and support team. Damage due to servicing that is not authorized by Dell is not covered by your warranty. Read and follow the safety instructions that came with the product.

 **CAUTION:** This troubleshooting procedure can erase data stored on the hard drive. Before you proceed, back up all files on the hard drive.

1. Run the appropriate diagnostic test. For more information, see Using System Diagnostics. Depending on the results of the diagnostics test, proceed as needed through the following steps.
2. If your system has a RAID controller and your hard drives are configured in a RAID array, perform the following steps:
 - a) Restart the system and press <F10> during system startup to run the Lifecycle Controller, and then run the Hardware Configuration wizard to check the RAID configuration.
See the Lifecycle Controller documentation or online help for information on RAID configuration.
 - b) Ensure that the hard drive(s) have been configured correctly for the RAID array.
 - c) Take the hard drive offline and reseal the drive.
 - d) Exit the configuration utility and allow the system to boot to the operating system.
3. Ensure that the required device drivers for your controller card are installed and are configured correctly. See the operating system documentation for more information.
4. Restart the system and enter the System Setup.
5. Verify that the controller is enabled and the drives are displayed in the System Setup.

If the problem persists, try troubleshooting the expansion cards or see [Getting Help](#).

Troubleshooting Expansion Cards

 **CAUTION:** Many repairs may only be done by a certified service technician. You should only perform troubleshooting and simple repairs as authorized in your product documentation, or as directed by the online or telephone service and support team. Damage due to servicing that is not authorized by Dell is not covered by your warranty. Read and follow the safety instructions that came with the product.

 **NOTE:** When troubleshooting an expansion card, see the documentation for your operating system and the expansion card.

1. Run the appropriate diagnostic test. For more information, see Using System Diagnostics.
2. Turn off the system and attached peripherals, and disconnect the system from the electrical outlet.
3. Open the system.
4. Ensure that each expansion card is firmly seated in its connector.
5. Close the system.
6. If the problem is not resolved, turn off the system and attached peripherals, and disconnect the system from the electrical outlet.
7. Open the system.
8. Remove all expansion cards installed in the system.
9. Close the system.

10. Run the appropriate diagnostic test. For more information, see Using System Diagnostics.
If the tests fail, see [Getting Help](#).
11. For each expansion card you removed in step 8, perform the following steps:
 - a) Turn off the system and attached peripherals, and disconnect the system from the electrical outlet.
 - b) Open the system.
 - c) Reinstall one of the expansion cards.
 - d) Close the system.
 - e) Run the appropriate diagnostic test. For more information, see Using System Diagnostics.

If a problem is still indicated, see [Getting Help](#).

Troubleshooting Processor



CAUTION: Many repairs may only be done by a certified service technician. You should only perform troubleshooting and simple repairs as authorized in your product documentation, or as directed by the online or telephone service and support team. Damage due to servicing that is not authorized by Dell is not covered by your warranty. Read and follow the safety instructions that came with the product.

1. Run the appropriate diagnostics test. See Using System Diagnostics for available diagnostic tests.
2. Turn off the system and attached peripherals, and disconnect the system from the electrical outlet.
3. Open the system.
4. Ensure that the processor and heat sink are properly installed.
5. Close the system.
6. Run the appropriate diagnostic test. For more information, see Using System Diagnostics.

If a problem is still indicated, see [Getting Help](#).

Using System Diagnostics

If you experience a problem with your system, run the system diagnostics before contacting Dell for technical assistance. The purpose of running system diagnostics is to test your system hardware without requiring additional equipment or risking data loss. If you are unable to fix the problem yourself, service and support personnel can use the diagnostics results to help you solve the problem.

Dell Online Diagnostics

Dell Online Diagnostics, a stand-alone suite of diagnostic programs or test modules, allows you to run diagnostic tests on the systems in a production environment, and helps you ensure maximum uptime of your systems. Online Diagnostics allows you to run diagnostic tests on chassis and storage components such as hard drives, physical memory, and network interface cards (NICs). You can use the graphical user interface (GUI) or the command line interface (CLI) to run diagnostic tests on the hardware that Online Diagnostics discovers on your system. For information about using diagnostics, see the *Dell Online PowerEdge Diagnostics User's Guide* under **Software** → **Serviceability Tools**, at dell.com/support/manuals.

Dell Embedded System Diagnostics

 **NOTE:** Also known as Enhanced Pre-boot System Assessment (ePSA) diagnostics.

The embedded system diagnostics provides a set of options for particular device groups or devices allowing you to:

- Run tests automatically or in an interactive mode
- Repeat tests
- Display or save test results
- Run thorough tests to introduce additional test options to provide extra information about the failed device(s)
- View status messages that inform you if tests are completed successfully
- View error messages that inform you of problems encountered during testing

When To Use The Embedded System Diagnostics

If a major component or device in the system does not operate properly, running the embedded system diagnostics may indicate component failure.

Running The Embedded System Diagnostics

The embedded system diagnostics program is run from the Dell Lifecycle Controller.

 **CAUTION:** Use the embedded system diagnostics to test only your system. Using this program with other systems may cause invalid results or error messages.

1. As the system boots, press <F11>.
2. Use the up and down arrow keys to select **System Utilities** → **Launch Dell Diagnostics** .

The **ePSA Pre-boot System Assessment** window is displayed, listing all devices detected in the system. The diagnostics starts executing the tests on all the detected devices.

System Diagnostic Controls

Menu	Description
Configuration	Displays the configuration and status information of all detected devices.
Results	Displays the results of all tests that are executed.
System Health	Provides the current overview of the system performance.
Event Log	Displays a time-stamped log of the results of all tests run on the system. This is displayed if at least one event description is recorded.





For information about embedded system diagnostics, see the *Dell Enhanced Pre-boot System Assessment User Guide* at dell.com/support/manuals.

Jumpers And Connectors

System Board Jumper Settings

For information on resetting the password jumper to disable a password, see [Disabling A Forgotten Password](#).

Table 4. System Board Jumper Settings

Jumper	Setting	Description
PWRD_EN	 2 4 6 (default)	The password feature is enabled (pins 2–4).
	 2 4 6	The password feature is disabled (pins 4–6). iDRAC local access is unlocked at the next AC power cycle.
NVRAM_CLR	 1 3 5 (default)	The configuration settings are cleared at the next system boot (pins 3–5).
	 1 3 5	The configuration settings are retained at system boot (pins 1–3).

Item	Connector	Description
13	USB1 top/USB2/USB3 BOT	USB connector
14	NIC1 TOP/NIC2 BOT	NIC connector
15	COM TOP/VGA BOT	Serial connector/video connector
16	INTRUSION	Chassis intrusion switch connector
17	12V_2/P2	Power connector
18	12V_1/P3	Power connector
19	A1, A2, A3, A4, A5, A6	Memory module sockets
20	CPU1	Processor socket
21	FAN2	External cooling fan connector
22	BP_CONN	Backplane connector
23	BATTERY	System battery connector
24	INT USB	Internal USB connector
25	FAN1	Internal cooling fan connector
26	PDB_I2C/P6	Power distribution board connector
27	ODD2/TBU	SATA_F connector for optical disk drive 2 or SATA tape backup unit
28	ODD1/TBU	SATA_E connector for optical disk drive 1 or, tape backup unit in software RAID-configured systems
29	SATA_A	SATA connector
30	JUMPER	Jumper
31	IDSDM	IDSDM connector
32	PERC card CONN	HDD activity connector

Disabling A Forgotten Password

The system's software security features include a system password and a setup password. The password jumper enables these password features or disables them and clears any password(s) currently in use.



CAUTION: Many repairs may only be done by a certified service technician. You should only perform troubleshooting and simple repairs as authorized in your product documentation, or as directed by the online or telephone service and support team. Damage due to servicing that is not authorized by Dell is not covered by your warranty. Read and follow the safety instructions that came with the product.

1. Turn off the system, including any attached peripherals, and disconnect the system from the electrical outlet.
2. Open the system.
3. Move the jumper on the system-board jumper from pins 2 and 4 to pins 4 and 6.
4. Close the system.

The existing passwords are not disabled (erased) until the system boots with the Jumper on pins 4 and 6. However, before you assign a new system and/or setup password, you must move the jumper back to pins 2 and 4.



 **NOTE:** If you assign a new system and/or setup password with the jumper on pins 4 and 6, the system disables the new password(s) the next time it boots.

5. Reconnect the system to its electrical outlet and turn the system on, including any attached peripherals.
6. Turn off the system, including any attached peripherals, and disconnect the system from the electrical outlet.
7. Open the system.
8. Move the jumper on the system-board jumper from pins 4 and 6 to pins 2 and 4.
9. Close the system.
10. Reconnect the system to its electrical outlet and turn the system on, including any attached peripherals.
11. Assign a new system and/or setup password.

Technical Specifications

Processor	
Processor type	<ul style="list-style-type: none"> • One Intel Xeon processor E5-2400 and E5-2400 v2 product family, or • One Intel Xeon processor E5-1400 and E5-1400 v2 product family, or • One Intel Pentium processor 1400 and 1400 v2 product family
Expansion Bus	
Bus type	PCI Express Generation 3 and 2
Expansion slots	<p>(Slot 1) One full-height, half-length x4 PCIe Gen2 card slot connected to Platform Controller Hub (PCH)</p> <p>(Slot 2) One full-height, full-length x1 PCIe Gen2 card slot connected to PCH</p> <p>(Slot 3) One full-height, full-length x16 PCIe Gen3 card slot connected to processor</p> <p>(Slot 4) One full-height, full-length x4 PCIe Gen3 card slot connected to processor</p> <p>(Slot 5) Not applicable</p> <p>(Slot 6) One full-height, half-length x4 PCIe Gen3 card slot connected to processor</p>
Memory	
Architecture	<p>800 MT/s, 1066 MT/s, 1333 MT/s, or 1600 MT/s DDR3 registered or unbuffered Error Correcting Code (ECC) DIMMs</p> <p>Support for advanced ECC or memory optimized operation</p>
Memory module sockets	Six 240-pin
Memory module capacities	
RDIMMs	2 GB (single-rank), 4 GB (single- and dual-rank), 8 GB (single- and dual-rank), 16 GB (dual-rank), and 32 GB (quad-rank)

Memory	
UDIMMs	2 GB (single-rank) and 4 GB (single- and dual-rank)
Minimum RAM	2 GB
Maximum RAM	
RDIMMs	192 GB
UDIMMs	24 GB

Drives	
Hard drives	
Four hard-drive systems	Up to four 3.5 inch, internal, cabled SATA, nearline SAS, or SAS hard drives.
Eight hard-drive systems	Up to eight 3.5 inch, internal, hot-swappable SATA, nearline SAS, SAS hard drives.
	 NOTE: 2.5 inch drives in 3.5 inch carriers are supported for SAS, SATA SSD or SAS SSD drives.
Sixteen hard-drive systems	Up to sixteen 2.5 inch, internal, hot-swappable SATA, nearline SAS, SAS , SAS SSD, or SATA SSD drives.
Optical drive	Up to two optional SATA DVD-ROM drive or DVD+/-RW drive.
	 NOTE: If your system is installed with a double-width GPU card, the system supports only one 5.25 inch removable media storage device.
Tape drive	One optional 5.25 inch tape drive.
	 NOTE: If your system is installed with a double-width GPU card, the system supports only one 5.25 inch removable media storage device.

Connectors	
Back	
NIC	Two 10/100/1000 Mbps
Serial	9-pin, DTE, 16550-compatible
USB	Six 4-pin USB 2.0-compliant
Video	15-pin VGA
iDRAC 7	One iDRAC 7 port
SD vFlash	One SD vFlash card slot
Front	
USB	Two 4-pin USB Host

Connectors

Video 15-pin VGA, for systems in rack mode only

Internal

USB One 4-pin, USB 2.0-compliant

Internal Dual SD Module Two optional flash memory card slots with the internal SD module

 **NOTE:** One card slot is dedicated for redundancy.

Video

Video type Integrated Matrox G200

Video memory 16 MB shared

Expanded Operating Temperature

 **NOTE:** When operating in the expanded temperature range, system performance may be impacted.

 **NOTE:** When operating in the expanded temperature range, ambient temperature warnings may be reported on the LCD and in the System Event Log.

≤ 10% of annual operating hours

5 °C to 40 °C at 5% to 85% RH with 26 °C dew point.

 **NOTE:** Outside the standard operating temperature (10 °C to 35 °C), the system can operate down to 5 °C or up to 40 °C for a maximum of 10% of its annual operating hours.

For temperatures between 35 °C and 40 °C, de-rate maximum allowable dry bulb temperature by 1 °C per 175 m above 950 m (1 °F per 319 ft).

≤ 1% of annual operating hours

–5 °C to 45 °C at 5% to 90% RH with 26 °C dew point.

 **NOTE:** Outside the standard operating temperature (10 °C to 35 °C), the system can operate down to –5 °C or up to 45 °C for a maximum of 1% of its annual operating hours.

For temperatures between 40 °C and 45 °C, de-rate maximum allowable dry bulb temperature by 1 °C per 125 m above 950 m (1 °F per 228 ft).

Expanded Operating Temperature Restrictions

- Both the internal cooling fan and the external cooling fan must be installed.
- The operating temperature specified is for a maximum altitude of 3048 m (10,000 ft).
- GPU is not supported.
- Non-redundant power supplies are not supported.
- Non Dell qualified peripheral cards and/or peripheral cards greater than 25 W are not supported.

Environmental

 **NOTE:** For additional information about environmental measurements for specific system configurations, see dell.com/environmental_datasheets.

Temperature

Maximum Temperature Gradient (Operating and Storage)	20 °C/h (36 °F/h)
Storage Temperature Limits	–40 °C to 65 °C (–40 °F to 149 °F)

Temperature (Continuous Operation)

Temperature Ranges (for altitude less than 950 m or 3117 ft)	10 °C to 35 °C (50 °F to 95 °F) with no direct sunlight on the equipment.
Humidity Percentage Range	10% to 80% Relative Humidity with 26 °C (78.8 °F) maximum dew point.

Relative Humidity

Storage	5% to 95% RH with 33 °C (91 °F) maximum dew point. Atmosphere must be non-condensing at all times.
---------	--

Maximum Vibration

Operating	0.26 G _{rms} at 5 Hz to 350 Hz (all operation orientations).
Storage	1.87 G _{rms} at 10 Hz to 500 Hz for 15 min (all six sides tested).

Maximum Shock

Operating	One shock pulse in the positive z axis of 31 G for 2.6 ms in all operational orientations.
Storage	Six consecutively executed shock pulses in the positive and negative x, y, and z axes (one pulse on each side of the system) of 71 G for up to 2 ms.

Maximum Altitude

Operating	3048 m (10,000 ft).
Storage	12,000 m (39,370 ft).

Operating Altitude De-rating

Up to 35 °C (95 °F)	Maximum temperature is reduced by 1 °C/300 m (1 °F/547 ft) above 950 m (3,117 ft).
35 °C to 40 °C (95 °F to 104 °F)	Maximum temperature is reduced by 1 °C/175 m (1 °F/319 ft) above 950 m (3,117 ft).
40 °C to 45 °C (104 °F to 113 °F)	Maximum temperature is reduced by 1 °C/125 m (1 °F/228 ft) above 950 m (3,117 ft).

Particulate Contamination

Environmental

 **NOTE:** This section defines the limits to help avoid IT equipment damage and/or failure from particulates and gaseous contamination. If it is determined that levels of particulates or gaseous pollution are beyond the limits specified below and are the reason for the damage and/or failures to your equipment, it may be necessary for you to re-mediate the environmental conditions that are causing the damage and/or failures. Re-mediation of environmental conditions will be the responsibility of the customer.

Air Filtration

 **NOTE:** Applies to data center environments only. Air filtration requirements do not apply to IT equipment designed to be used outside a data center, in environments such as an office or factory floor.

Data center air filtration as defined by ISO Class 8 per ISO 14644-1 with a 95% upper confidence limit.

 **NOTE:** Air entering the data center must have MERV11 or MERV13 filtration.

Conductive Dust

 **NOTE:** Applies to data center and non-data center environments.

Air must be free of conductive dust, zinc whiskers, or other conductive particles.

Corrosive Dust

 **NOTE:** Applies to data center and non-data center environments.

- Air must be free of corrosive dust.
- Residual dust present in the air must have a deliquescent point less than 60% relative humidity.

Gaseous Contamination

 **NOTE:** Maximum corrosive contaminant levels measured at $\leq 50\%$ relative humidity.

Copper Coupon Corrosion Rate

$< 300 \text{ \AA/month}$ per Class G1 as defined by ANSI/ISA71.04-1985.

Silver Coupon Corrosion Rate

$< 200 \text{ \AA/month}$ as defined by AHSRAE TC9.9.

System Messages

LCD Messages

 **NOTE:** Applicable only if your system has an LCD display.

The LCD messages consist of brief text messages that refer to events recorded in the System Event Log (SEL). For information on the SEL and configuring system management settings, see the systems management software documentation.

 **NOTE:** If your system fails to boot, press the System ID button for at least 5 seconds until an error code is displayed on the LCD. Record the code, then see System Error Messages.

Viewing LCD Messages

If a system error occurs, the LCD screen will turn amber. Press the Select button to view the list of errors or status messages. Use the Left and Right buttons to highlight an error number, and press the Select button to view the error.

Removing LCD Messages

For faults associated with sensors, such as temperature, voltage, fans, and so on, the LCD message is automatically removed when that sensor returns to a normal state. For other faults, you must take action to remove the message from the display:

- Clear the SEL — You can perform this task remotely, but you will lose the event history for the system.
- Power cycle — Turn off the system and disconnect it from the electrical outlet; wait approximately 10 seconds, reconnect the power cable, and restart the system.

System Error Messages

System messages appear on the monitor to notify you of a possible problem with the system. These messages refer to events recorded in the System Event Log (SEL). For information on the SEL and configuring system management settings, see the systems management software documentation.

Some messages are also displayed in an abbreviated form on the system's LCD, if the system includes that feature.

 **NOTE:** The LCD error messages listed here are displayed in the simple format. See Setup Menu to select the format in which the messages are displayed.

 **NOTE:** If you receive a system message not listed here, check the documentation of the application that was running when the message was displayed or the operating system's documentation for an explanation of the message and recommended action.

 **NOTE:** In some messages, a particular system component is identified by name ("`<name>`") component number ("`<number>`"), or location ("`bay`").

Error Code	Message Information	
AMP0302	Message	The system board <name> current is greater than the upper warning threshold.
	Details	System board <name> current is outside of the optimum range.
	Action	<ol style="list-style-type: none"> 1. Review system power policy. 2. Check system logs for power related failures. 3. Review system configuration changes. 4. If the issue persists, see Getting Help.
AMP0303	Message	The system board <name> current is greater than the upper critical threshold.
	LCD Message	System board <name> current is outside of range.
	Details	System board <name> current is outside of the optimum range.
	Action	<ol style="list-style-type: none"> 1. Review system power policy. 2. Check system logs for power related failures. 3. Review system configuration changes. 4. If the issue persists, see Getting Help.
ASR0000	Message	The watchdog timer expired.
	Details	The operating system or an application failed to communicate within the time-out period.
	Action	Check the operating system, application, hardware, and system event log for exception events.
ASR0001	Message	The watchdog timer reset the system.
	Details	The operating system or an application failed to communicate within the time-out period. The system was reset.
	Action	Check the operating system, application, hardware, and system event log for exception events.
ASR0002	Message	The watchdog timer powered off the system.
	Details	The operating system or an application failed to communicate within the time-out period. The system was shut down.
	Action	Check the operating system, application, hardware, and system event log for exception events.

Error Code	Message Information	
ASR0003	Message	The watchdog timer power cycled the system.
	Details	The operating system or an application failed to communicate within the time-out period. The system was power-cycled.
	Action	Check the operating system, application, hardware, and system event log for exception events.
BAT0002	Message	The system board battery has failed.
	LCD Message	The system board battery has failed. Check battery.
	Details	The system board battery is either missing or bad.
	Action	See Getting Help .
BAT0017	Message	The <name> battery has failed.
	LCD Message	The <name> battery has failed. Check battery.
	Details	The <name> battery is either missing, bad, or unable to charge due to thermal issues.
	Action	Check system fans. If the problem persists, see Getting Help .
CPU0000	Message	CPU <number> has an internal error (IERR).
	LCD Message	CPU <number> has an internal error (IERR).
	Details	System Event Log and Operating System Logs may indicate that the exception is external to the processor.
	Action	Review System Event Log and Operating System Logs. If the issue persists, see Getting Help .
CPU0001	Message	CPU <number> has a thermal trip (over-temperature) event.
	LCD Message	CPU <number> has a thermal trip. Check CPU heat sink.
	Details	The processor temperature increased beyond the operational range.
	Action	Review the logs for fan failures. If no fan failures are detected, check inlet temperature (if available) and reinstall processor heat sink. If the problem persists, see Getting Help .
CPU0005	Message	CPU <number> configuration is unsupported.
	LCD Message	CPU <number> configuration is unsupported. Check CPU or BIOS revision.
	Details	System is unable to boot or may run in a degraded state.

Error Code	Message Information	
	Action	Review the technical specifications for supported processor types.
CPU0010	Message	CPU <number> is throttled.
	Details	The CPU is throttled due to thermal or power conditions.
	Action	Review system logs for power or thermal exceptions.
CPU0023	Message	CPU <number> is absent.
	LCD Message	CPU <number> is absent. Check CPU.
	Action	Verify processor installation. If present, re-seat the processor.
CPU0204	Message	CPU <number> <name> voltage is outside of range.
	LCD Message	CPU <number> <name> voltage is outside of range. Re-seat CPU.
	Details	Voltages outside the allowable range may damage electrical components or may cause the system to shutdown.
	Action	<ol style="list-style-type: none"> 1. Turn off the system and remove input power for one minute. 2. Ensure the processor is seated correctly. 3. Reapply input power and turn on the system. 4. If the issue persists, see Getting Help.
CPU0700	Message	CPU <number> initialization error detected.
	LCD Message	CPU <number> initialization error detected. Power cycle system.
	Details	System BIOS was unable to initialize the processor.
	Action	<ol style="list-style-type: none"> 1. Turn off the system and remove input power for one minute. 2. Ensure the processor is seated correctly. 3. Reapply input power and turn on the system. 4. If the issue persists, see Getting Help.
CPU0701	Message	CPU <number> protocol error detected.
	LCD Message	CPU <number> protocol error detected. Power cycle system.
	Details	System event log and operating system logs may indicate that the exception is external to the processor.
	Action	<ol style="list-style-type: none"> 1. Check system and operating system logs for exceptions. If no exceptions are found, continue.

Error Code	Message Information	
		<ol style="list-style-type: none"> 2. Turn off the system and remove input power for one minute. 3. Ensure the processor is seated correctly. 4. Reapply input power and turn on the system. 5. If the issue persists, see Getting Help.
CPU0702	Message	CPU bus parity error detected.
	LCD Message	CPU bus parity error detected. Power cycle system.
	Details	System event log and operating system logs may indicate that the exception is external to the processor.
	Action	<ol style="list-style-type: none"> 1. Check system and operating system logs for exceptions. If no exceptions are found, continue. 2. Turn off the system and remove input power for one minute. 3. Ensure the processor is seated correctly. 4. Reapply input power and turn on the system. 5. If the issue persists, see Getting Help.
CPU0703	Message	CPU bus initialization error detected.
	LCD Message	CPU bus initialization error detected. Power cycle system.
	Details	System event log and operating system logs may indicate that the exception is external to the processor.
	Action	<ol style="list-style-type: none"> 1. Check system and operating system logs for exceptions. If no exceptions are found, continue. 2. Turn off the system and remove input power for one minute. 3. Ensure the processor is seated correctly. 4. Reapply input power and turn on the system. 5. If the issue persists, see Getting Help.
CPU0704	Message	CPU <number> machine check error detected.
	LCD Message	CPU <number> machine check error detected. Power cycle system.
	Details	System event log and operating system logs may indicate that the exception is external to the processor.
	Action	<ol style="list-style-type: none"> 1. Check system and operating system logs for exceptions. If no exceptions are found, continue. 2. Turn off the system and remove input power for one minute. 3. Ensure the processor is seated correctly. 4. Reapply input power and turn on the system.

Error Code	Message Information	
FAN0000	Message Details Action	5. If the issue persists, see Getting Help . Fan <number> RPM is less than the lower warning threshold. Fan operating speed is out of range. Remove and reinstall the fan. If the issue persists, see Getting Help .
FAN0001	Message LCD Message Details Action	Fan <number> RPM is less than the lower critical threshold. Fan <number> RPM is outside of range. Check fan. Fan operating speed is out of range. Remove and reinstall the fan. If the issue persists, see Getting Help .
FAN1201	Message LCD Message Details Action	Fan redundancy is lost. Fan redundancy is lost. Check fans. Fan has failed. Remove and reinstall failed fans or install additional fans.
HWC1001	Message LCD Message Details Action	The <name> is absent. The <name> is absent. Check hardware. The absent device may be necessary for proper operation. System functionality may be degraded. Reinstall or reconnect the hardware.
HWC2003	Message LCD Message Details Action	The storage <name> cable is not connected, or is improperly connected. Storage <name> cable or interconnect failure. Check connection. The cable may be necessary for proper operation. System functionality may be degraded. Check if the cable is present, then reinstall or reconnect.
HWC2005	Message LCD Message Details	The system board <name> cable is not connected, or is improperly connected. System board <name> cable connection failure. Check connection. The cable may be necessary for proper operation. System functionality may be degraded.

Error Code	Message Information	
	Action	Check if the cable is present, then reinstall or reconnect.
MEM0000	Message	Persistent correctable memory errors detected on a memory device at location(s) <i><location></i> .
	Details	This is an early indicator of a possible future uncorrectable error.
	Action	Re-seat the memory modules. If the issue persists, see Getting Help .
MEM0001	Message	Multi-bit memory errors detected on a memory device at location(s) <i><location></i> .
	LCD Message	Multi-bit memory error on <i><location></i> . Re-seat memory.
	Details	The memory module has encountered an uncorrectable error. System performance may be degraded. The operating system and/or applications may fail as a result.
	Action	Re-seat the memory modules. If the issue persists, see Getting Help .
MEM0007	Message	Unsupported memory configuration; check memory device at location <i><location></i> .
	LCD Message	Unsupported memory configuration. Check memory <i><location></i> .
	Details	The memory may not be seated correctly, misconfigured, or has failed. Memory size is reduced.
	Action	Check the memory configuration. Re-seat the memory modules. If the issue persists, see Getting Help .
MEM0701	Message	Correctable memory error rate exceeded for <i><location></i> .
	Details	The memory may not be operational. This an early indicator of a possible future uncorrectable error.
	Action	Re-seat the memory modules. If the issue persists, see Getting Help .
MEM0702	Message	Correctable memory error rate exceeded for <i><location></i> .
	LCD Message	Correctable memory error rate exceeded for <i><location></i> . Re-seat memory.
	Details	The memory may not be operational. This an early indicator of a possible future uncorrectable error.
	Action	Re-seat the memory modules. If the issue persists, see Getting Help .
MEM1205	Message	Memory mirror redundancy is lost. Check memory device at location(s) <i><location></i> .

Error Code	Message Information	
	LCD Message	Memory mirror lost on <i><location></i> . Power cycle system.
	Details	The memory may not be seated correctly, misconfigured, or has failed.
	Action	Check the memory configuration. Re-seat the memory modules. If the issue persists, see Getting Help .
MEM1208	Message	Memory spare redundancy is lost. Check memory device at location <i><location></i> .
	LCD Message	Memory spare lost on <i><location></i> . Power cycle system.
	Details	Memory sparing is no longer available.
	Action	Re-seat the memory modules. If the issue persists, see Getting Help .
MEM8000	Message	Correctable memory error logging disabled for a memory device at location <i><location></i> .
	LCD Message	SBE log disabled on <i><location></i> . Re-seat memory.
	Details	Errors are being corrected but no longer logged.
	Action	Review system logs for memory exceptions. Reinstall memory at location <i><location></i> .
PCI1302	Message	A bus time-out was detected on a component at bus <i><bus></i> device <i><device></i> function <i><func></i> .
	Details	System performance may be degraded. The device has failed to respond to a transaction.
	Action	Cycle input power, update component drivers, if device is removable, reinstall the device.
PCI1304	Message	An I/O channel check error was detected.
	LCD Message	I/O channel check error detected. Power cycle system.
	Action	Cycle input power, update component drivers, if device is removable, reinstall the device.
PCI1308	Message	A PCI parity error was detected on a component at bus <i><bus></i> device <i><device></i> function <i><func></i> .
	LCD Message	PCI parity error on bus <i><bus></i> device <i><device></i> function <i><func></i> . Power cycle system.
	Details	System performance may be degraded, PCI device may fail to operate, or system may fail to operate.

Error Code	Message Information	
PCI1320	Action	Cycle input power, update component drivers, if device is removable, reinstall the device.
	Message	A bus fatal error was detected on a component at bus <bus>device<device>function <func>.
	LCD Message	Bus fatal error on bus <bus> device <device> function <func>. Power cycle system.
	Details	System performance may be degraded, or system may fail to operate.
PCI1342	Action	Cycle input power, update component drivers, if device is removable, reinstall the device.
	Message	A bus time-out was detected on a component at slot <number>.
	Details	System performance may be degraded, or system may fail to operate.
PCI1348	Action	Cycle input power, update component drivers, if device is removable, reinstall the device.
	Message	A PCI parity error was detected on a component at slot <number>.
	LCD Message	PCI parity error on slot <number>. Re-seat PCI card.
	Details	System performance may be degraded, or system may fail to operate.
PCI1360	Action	Cycle input power, update component drivers, if device is removable, reinstall the device.
	Message	A bus fatal error was detected on a component at slot <number>.
	LCD Message	Bus fatal error on slot <number>. Re-seat PCI card.
	Details	System performance may be degraded, or system may fail to operate.
PDR0001	Action	Cycle input power, update component drivers, if device is removable, reinstall the device.
	Message	Fault detected on drive <number>.
	LCD Message	Fault detected on drive <number>. Check drive.
	Details	The controller detected a failure on the disk and has taken the disk offline.
PDR1016	Action	Remove and re-seat the failed disk. If the issue persists, see Getting Help .
	Message	Drive <number> is removed from disk drive bay <bay>.

Error Code	Message Information	
PST0128	LCD Message	Drive <number> removed from disk drive bay <bay>. Check drive.
	Details	The controller detected that the drive was removed.
	Action	Verify drive installation. Re-seat the failed drive. If the issue persists, see Getting Help .
	Message	No memory is detected.
PST0129	LCD Message	No memory is detected. Inspect memory devices.
	Details	System BIOS was unable to detect memory in the system.
	Action	Re-seat the memory modules. If the issue persists, see Getting Help .
	Message	Memory is detected, but is not configurable.
PSU0001	LCD Message	Memory is detected, but is not configurable. Check memory devices.
	Details	System BIOS detected memory, but was unable to configure the memory for system operation.
	Action	Compare system memory installation to supported system memory configurations.
	Message	Power supply <number> failed.
PSU0002	LCD Message	PSU <number> failed. Check PSU.
	Action	Remove and reinstall the power supply. If the issue persists, see Getting Help .
	Message	A predictive failure detected on power supply <number>.
	LCD Message	Predictive failure on PSU <number>. Check PSU.
PSU0003	Details	System performance and power redundancy may be degraded or lost.
	Action	Remove and reinstall the power supply at the next service window. If the issue persists, see Getting Help .
	Message	The power input for power supply <number> is lost.
	LCD Message	Power input for PSU <number> is lost. Check PSU cables.
Details	The power supply is installed correctly but an input source is not connected or is not functional.	
Action	Verify the input source is attached to the power supply. Verify the input power is within the operating requirements for the power supply.	

Error Code	Message Information	
PSU0006	Message	Power supply <number> type mismatch.
	LCD Message	Power supply <number> is incorrectly configured. Check PSU.
	Details	Power supplies should be of the same input type and power rating.
	Action	Install matched power supplies and review proper configuration in this manual.
PSU0016	Message	Power supply <number> is absent.
	LCD Message	PSU <number> is absent. Check PSU.
	Details	The power supply has been removed or has failed.
	Action	<ol style="list-style-type: none"> 1. Remove and reinstall the power supply. 2. Check cables and subsystem components in the system for damage. 3. If the issue persists, see Getting Help.
PSU0031	Message	Cannot communicate with power supply <number>.
	LCD Message	Cannot communicate with PSU <number>. Re-seat PSU.
	Details	The power supply may operate, however power supply monitoring is degraded. System performance may be degraded.
	Action	Remove and reinstall the power supply. If the issue persists, see Getting Help .
PSU0032	Message	The temperature for power supply <number> is in a warning range.
	Details	System performance may be degraded.
	Action	Check the system operating environment, including airflow and inlet temperature. Check system logs for temperature and thermal component failures.
PSU0033	Message	The temperature for power supply <number> is outside of the allowable range.
	LCD Message	PSU <number> temperature outside of range. Check PSU.
	Details	System performance may be degraded.
	Action	Check the system operating environment, including airflow and inlet temperature. Check system logs for temperature and thermal component failures.

Error Code	Message Information	
PSU0034	Message	An under voltage fault detected on power supply <number>.
	LCD Message	An under voltage fault detected on PSU <number>. Check power source.
	Details	This failure may be the result of an electrical issue with cables or subsystem components in the system.
	Action	<ol style="list-style-type: none"> 1. Remove and reinstall the power supply. 2. Check cables and subsystem components in the system for damage. 3. If the issue persists, see Getting Help.
PSU0035	Message	An over voltage fault detected on power supply <number>.
	LCD Message	Over voltage fault on PSU <number>. Check PSU.
	Action	Check input power or reinstall the power supply. If the issue persists, see Getting Help .
PSU0036	Message	An over current fault detected on power supply <number>.
	LCD Message	An over current fault detected on PSU <number>. Check PSU.
	Details	This failure may be the result of an electrical issue with cables or subsystem components in the system.
	Action	<ol style="list-style-type: none"> 1. Remove and reinstall the power supply. 2. Check cables and subsystem components in the system for damage. 3. If the issue persists, see Getting Help.
PSU0037	Message	Fan failure detected on power supply <number>.
	LCD Message	Fan failure detected on PSU <number>. Check PSU.
	Action	Check for fan blockage. If the problem persists, see Getting Help .
PSU0076	Message	A power supply wattage mismatch is detected; power supply <number> is rated for <value> watts.
	LCD Message	PSU wattage mismatch; PSU <number> = <value>watts
	Details	Power supplies should be of the same input type and power rating.
	Action	Install matched power supplies and review this manual for proper configuration.

Error Code	Message Information	
PSU1201	Message	Power supply redundancy is lost.
	Details	The power supply tries to operate in a degraded state. System Performance and power redundancy may be degraded or lost.
	Action	Check input power. Reinstall the power supply. If the issue persists, see Getting Help .
PSU1204	Message	The power supplies are not redundant. Insufficient resources to maintain normal operations.
	LCD Message	PSU redundancy degraded. Check PSU cables.
	Details	The current power operational mode is non-redundant because of a power supply exception, a power supply inventory change, or a system power inventory change.
	Action	Check the event log for power supply failures. Review system configuration and power consumption.
PWR1004	Message	The system performance degraded because power capacity has changed.
	Details	The system may power down or operate in a performance degraded state.
	Action	Check the event log for power supply failures. Review system configuration and power consumption and upgrade or install power supplies accordingly.
PWR1005	Message	The system performance degraded because the user-defined power capacity has changed.
	Details	The user-defined power settings have affected system operation.
	Action	If unintended, review system configuration changes and power policy.
PWR1006	Message	The system halted because system power exceeds capacity.
	LCD Message	System power demand exceeds capacity. System halted.
	Details	The system halted because system power exceeds capacity.
	Action	Review system configuration, upgrade power supplies or reduce system power consumption.
RFM1008	Message	Failure detected on Removable Flash Media <name>.
	LCD Message	Removable Flash Media <name> failed. Check SD Card.

Error Code	Message Information	
	Details	An error was reported during a SD card read or write.
	Action	Reseat the flash media. If the problem persists, see Getting Help .
RFM1014	Message	Removable Flash Media <name> is write protected.
	LCD Message	Removable Flash Media <name> is write protected. Check SD Card.
	Details	The card is write-protected by the physical latch on the SD card. A write-protected card cannot be used.
	Action	If unintended, remove the media and disable write protection.
RFM1201	Message	Internal Dual SD Module redundancy is lost.
	LCD Message	Internal Dual SD Module redundancy is lost. Check SD Card.
	Details	Either one or both the SD cards are not functioning properly.
	Action	See Getting Help .
RFM2001	Message	Internal Dual SD Module <name> is absent.
	LCD Message	Internal Dual SD Module <name> is absent. Check SD Card.
	Details	The SD card module is not detected or not installed.
	Action	If unintended, reinstall the SD module.
RFM2002	Message	Internal Dual SD Module <name> is offline.
	Details	The SD card module is installed but may be improperly installed or configured incorrectly.
	Action	Reinstall the SD module.
RFM2004	Message	Failure detected on Internal Dual SD Module <name>.
	LCD Message	Internal Dual SD Module <name> failed. Check SD Card.
	Details	The SD card module is installed but improperly configured or failed to initialize.
	Action	Reinstall the SD module and remove and reinstall SD cards.
RFM2006	Message	Internal Dual SD Module <name> is write protected.
	Details	The module is write-protected. Changes may not be written to the media.
	Action	If unintended, remove the media and disable write protection.

Error Code	Message Information	
SEC0031	Message	The chassis is open while the power is on.
	LCD Message	Intrusion detected. Check chassis cover.
	Details	The chassis is open. System performance may be degraded, and security may be compromised.
	Action	Close the chassis. Check system logs.
SEC0033	Message	The chassis is open while the power is off.
	LCD Message	Intrusion detected. Check chassis cover.
	Details	The chassis was opened while the power was off. System security may have been compromised.
	Action	Close the chassis and verify hardware inventory. Check system logs.
SEL0006	Message	All event logging is disabled.
	Details	This message is displayed when all event logging has been disabled by the user.
	Action	If unintended, re-enable logging.
SEL0008	Message	Log is full.
	Details	When the event log is full, additional events are not written to the log. Older events may be overwritten and lost. This message may also appear if the user disabled event logging.
	Action	Backup and clear log.
SEL0012	Message	Could not create or initialize the system event log.
	Details	If the system event log fails to initialize, platform status and failure events are not captured. Some management software do not report platform exceptions.
	Action	Reboot the management controller or iDRAC. Cycle system input power. If problem persists call support.
SEL1204	Message	An unknown system hardware failure detected.
	LCD Message	Unknown system hardware failure.
	Details	If the system event log failed to initialize, platform status and failure events are not captured. Some management software do not report platform exceptions.

Error Code	Message Information	
TMP0118	Action	Re-configure system to the minimum supported configuration. If issues persists, contact support.
	Message	The system inlet temperature is less than the lower warning threshold.
	LCD Message	System inlet temperature is outside of range.
	Details	Ambient air temperature is too cool.
TMP0119	Action	Check the system operating environment.
	Message	The system inlet temperature is less than the lower critical threshold.
	LCD Message	System inlet temperature is outside of range.
	Details	Ambient air temperature is too cool.
TMP0120	Action	Check the system operating environment.
	Message	The system inlet temperature is greater than the upper warning threshold.
	LCD Message	System inlet temperature is outside of range.
	Details	Ambient air temperature is too warm or one or more fans may have failed.
TMP0121	Action	Check the system operating environment and review event log for fan failures.
	Message	The system inlet temperature is greater than the upper critical threshold.
	LCD Message	System inlet <name> temperature is outside of range. Check Fans.
	Details	Ambient air temperature is too warm or one or more fans may have failed.
VLT0204	Action	Check the system operating environment and review event log for fan failures.
	Message	The system board <name> voltage is outside of the allowable range.
	LCD Message	System board voltage is outside of range.
Details	System hardware detected an over voltage or under voltage condition.	
		If multiple voltage exceptions occur consecutively the system may power down in fail-safe mode.

Error Code	Message Information
	Action
	<ol style="list-style-type: none"> 1. Review system logs for power supply exceptions. 2. Re-configure the system to minimum configuration, inspect and reinstall system cables. 3. If the issue persists, see Getting Help.

Warning Messages

A warning message alerts you to a possible problem and prompts you to respond before the system continues a task. For example, before you format a hard drive, a message warns you that you may lose all data on the hard drive. Warning messages usually interrupt the task and require you to respond by typing y (yes) or n (no).

 **NOTE:** Warning messages are generated by either the application or the operating system. For more information, see the documentation that accompanied the operating system or application.

Diagnostic Messages

The system diagnostic utilities may issue messages if you run diagnostic tests on your system. See “Using System Diagnostics” chapter for more information about system diagnostics.

Alert Messages

Systems management software generates alert messages for your system. Alert messages include information, status, warning, and failure messages for drive, temperature, fan, and power conditions. For more information, see the systems management software documentation.

Getting Help

Contacting Dell

 **NOTE:** If you do not have an active Internet connection, you can find contact information on your purchase invoice, packing slip, bill, or Dell product catalog.

Dell provides several online and telephone-based support and service options. Availability varies by country and product, and some services may not be available in your area. To contact Dell for sales, technical support, or customer service issues:

1. Visit dell.com/support
2. Select your support category.
3. Verify your country or region in the Choose a Country/Region drop-down menu at the top of page.
4. Select the appropriate service or support link based on your need.