



Cisco 8540 Wireless LAN Controller Deployment Guide

[Cisco 8540 Wireless LAN Controller Deployment Guide](#) 2

[Introduction](#) 2

[Prerequisites](#) 2

[Product Overview](#) 3

[Cisco 8540 Controller Key Attributes](#) 4

[AP Platform Support](#) 5

[Platform Components](#) 6

[SFP Support](#) 13

[Image Specifications](#) 14

[Fault Tolerance Capability](#) 14

[Customer Replaceable Units](#) 16

[Link Aggregation \(LAG\)](#) 16

[Inter-Platform Mobility and Guest Anchor Support](#) 16

[Infrastructure Multicast](#) 16

[New Mobility and MC Support](#) 17

[Look and Feel of the Cisco 8540 Wireless LAN Controller](#) 17

[Licensing](#) 23

Revised: November 12, 2015,

Cisco 8540 Wireless LAN Controller Deployment Guide

Introduction

This document introduces the Cisco 8540 Wireless LAN Controller (WLC), and provides general guidelines for its deployment. The purpose of this document is to:

- Provide an overview of the Cisco 8540 WLC, and its deployment within the Cisco unified architecture.
- Highlight key service provider features.
- Provide design recommendations and considerations specific to the Cisco 8540 controller.

Prerequisites

Requirements

There are no specific requirements for this document.

Components Used

This document is not restricted to specific software and hardware versions.

The information in this document is created from the devices in a specific lab environment. All of the devices used in this document started with a cleared (default) configuration. If your network is live, make sure that you understand the potential impact of any command.

Conventions

Refer to [Cisco Technical Tips Conventions](#) for more information on document conventions.

Product Overview



The existing Cisco 8510 series controller scales up to 6,000 APs, 64,000 clients, and 10 Gbps maximum throughput. The explosion of mobile clients in enterprise empowered by bring your own device (BYOD), the deployment of wireless in mission-critical applications, and the adoption of Wi-Fi in service provider networks enabling new business models require wireless networks to provide larger AP Scale, client scale and higher throughput.

The Cisco Unified Wireless Network Software Release 8.1 addresses these key challenges. Release 8.1 delivers the new Cisco 8540 wireless controller with support for 40 Gbps throughput, 6,000 APs, and 64,000 clients to ensure better performance and scale for business critical networks.

The following table captures some of the key hardware capabilities of this new platform.

Table 1: Hardware Capabilities of Cisco 8540 WLC

Hardware Capabilities	8540
Chassis Height	2 RU
Throughput	40 Gbps
AP Support	6,000
Client Support	64,000
Data Ports	4x SFP+
Storage	Dual SSD with Hardware RAID
Storage Temperature	-40°C – 65°C
Operating Temperature	5 – 40°C
Operating Humidity	10 – 90% (non-condensing)
Power Options	1200 W AC, 930 W DC Redundant PSUs

Cisco 8540 Controller Key Attributes

Some of the key attributes of the Cisco 8540 controller are:

- High AP scalability (6,000 APs in 2 RU)
- High client density (64,000 clients in 2 RU)
- High throughput of 40 Gbps with 2 RU
- Support for 6,000 APs, 6,000 AP groups, 2,000 FlexConnect groups, and up to 100 APs per FlexConnect group
- Support for 4095 VLANs
- Support for 50,000 RFIDs tracking, and the detection and containment of up to 24,000 rogue APs, and up to 32,000 rogue clients
- 25,000 RFID tags
- 3,20,000 AVC Flows
- PMK cache size of 64,000
- High availability with sub-second AP and client SSO
- TrustSec SXP Support
- Support of all AP modes of operation (Local, FlexConnect, Monitor, Rogue Detector, Sniffer, Bridge, and Flex+Bridge)
- Right to Use (RTU) licensing for ease of license enablement and ongoing licensing operations

The following table shows the Cisco enterprise campus controllers comparison at a glance:

Table 2: Cisco Enterprise Campus Controllers comparison

Attributes	8540	8510	7510
Deployment type	Enterprise Large campus + SP Wi-Fi Full Scale Branch	Enterprise Large campus + SP Wi-Fi Full Scale Branch	Central site controller for large number of distributed, controller-less branches
Operational Modes	All AP modes	All AP modes	FlexConnect, Flex+Bridge
Maximum Scale	6,000 APs 64,000 clients	6,000 APs 64,000 clients	6,000 APs 64,000 clients
AP Count Range	1 – 6,000	300 – 6,000	300 – 6,000
Licensing	Right to Use (with EULA)	Right to Use (with EULA)	Right to Use (with EULA)
Connectivity	4 x 10 G ports	2 x 10 G ports	2 x 10 G ports
Power	1200 W AC, 930 W DC Dual redundant Hot-swappable PSU	AC/DC dual redundant	AC/DC dual redundant

Attributes	8540	8510	7510
Maximum Number of FlexConnect Groups	2,000	2,000	2,000
Maximum Number of APs per FlexConnect Group	100	100	100
Maximum Number of Rogue APs Management	24,000	32,000	32,000
Maximum Number of Rogue Clients Management	32,000	24,000	24,000
Maximum Number of RFID	50,000	50,000	50,000
Maximum APs per RRM Group	6,000	6,000	6,000
Maximum AP Groups	6,000	6,000	6,000
Maximum Interface Groups	512	512	512
Maximum Interfaces per Interface Group	64	64	64
Maximum VLANs Supported	4095	4095	4095
Maximum WLANs Supported	512	512	512
Fast Secure Roaming Clients/Max PMK Cache	64,000	64,000	64,000



Note Feature support unless otherwise specified will be the same as in 8510.

AP Platform Support

The Cisco 8540 supports the following access point models:

- 1260, 3500, 600
- 1600, 2600, 3600
- 1700, 2700, 3700
- OEAP 600
- 702I, 702W

- Cisco AP802 access point module
- 1530, 1552WU, 1550, 1570
- 1040, 1140, 1260 support extended to 8.1 with 8.0 parity

Platform Components

Cisco 8540 Front Panel View

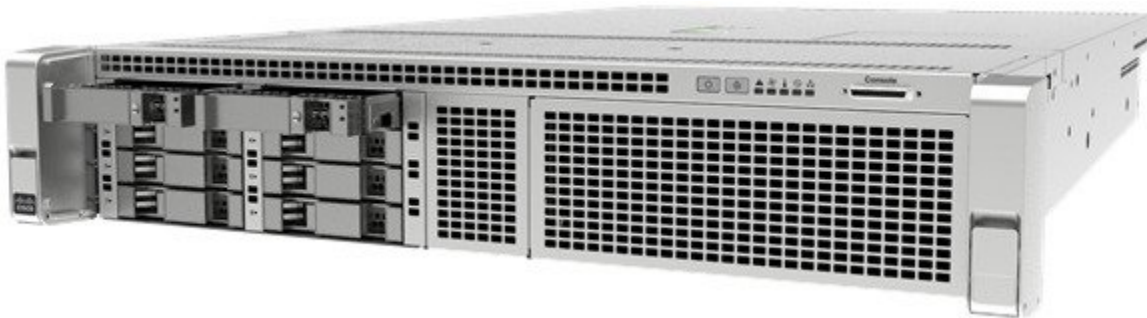

Cisco 8540 wireless LAN controller supports several buttons, LED indicators, and a KVM connector on the front panel. It includes a power button and Locator LED button, along with the following LEDs: System status, PSU status, Fan status, Network LED, and Temperature LED.

Power On Switch and LED Indicator

A Power Button push switch with integrated LED is located on the front panel.

Table 3: Power On Switch and LED Indicator

LED Indicator Color	Function	
Bi-color Yellow (Amber) Green	Card Power Status	
	State	Decode
	Off	Power Off
	Amber On	Soft Off
	Green On	Power On

Locator Switch and LED Indicator

A Unit Identify push switch with integrated LED is available on the front panel and rear panel . Each press on the button toggles between active and non-active states.

System Status LED Indicator

The system status LED located on the front panel indicates the overall system health.

Table 4: System Status LED Indicator

LED Indicator Color	Function	
Bi-color Yellow (Amber) Green	System Status	
	State	Decode
	Off	Undefined
	Green On	Card is in normal operating condition
	Amber On	System is in a degraded operational state
	Amber Blinking	Critical fault state

Fan Status LED Indicator

The Fan Status LED located on front panel indicates the fan health.

Table 5: Fan Status LED Indicator

LED Indicator Color	Function	
Bi-color Yellow (Amber) Green	Fan Status	
	State	Decode
	Off	Undefined
	Green On	Fans are operating and no error condition has been detected
	Amber On	Fans are in a degraded operational state <ul style="list-style-type: none">• One of N fans has a fault
	Amber Blinking	Critical fault state <ul style="list-style-type: none">• Two or more fans has a fault



Note Adaptive fan speed to control noise issues seen with 8540 FCS hardware is introduced in release version 8.1.131.0.

Temperature Status LED Indicator

The temperature status LED is located on the front panel and indicates whether or not the system is operating within acceptable temperature limits.

Table 6: Temperature Status LED Indicator

LED Indicator Color	Function	
Bi-color Yellow (Amber) Green	Temperature Status	
	State	Decode
	Off	Undefined
	Green On	System is operating at normal temperature
	Amber On	One or more temperature sensors reaches UCR threshold
	Amber Blinking	One or more temperature sensors reaches UNR threshold

Power Supply Status LED Indicator

The power supply status LED is located on the front panel and indicates the proper functioning of the power supply.

Table 7: Power Supply Status LED Indicator

LED Indicator Color	Function	
Bi-color Yellow (Amber) Green	AC Power Supply Status	
	State	Decode
	Off	Undefined
	Green On	AC power supplies are operating and no error condition has been detected
	Amber On	One or more power supplies are in a degraded operational state
Amber Blinking	One or more power supplies are in a critical fault state	

Network Link LED Indicator

The network LED is located on the front panel and indicates if any of the on-board networking ports are connected and operating.

Table 8: Network Link LED Indicator

LED Indicator Color	Function	
Single Color Green	Network Link Status	
	State	Decode
	Off	Undefined
	Green On	Link on any of the ports, but no activity
Green Blinking	Activity on any of the ports	

Front Panel KVM Break-out Connector

A single female connector provides access to video, two USB ports for keyboard and mouse, and an RS-232C console serial port. An external breakout connector to industry standard interfaces is required. The following figure shows an example cable.

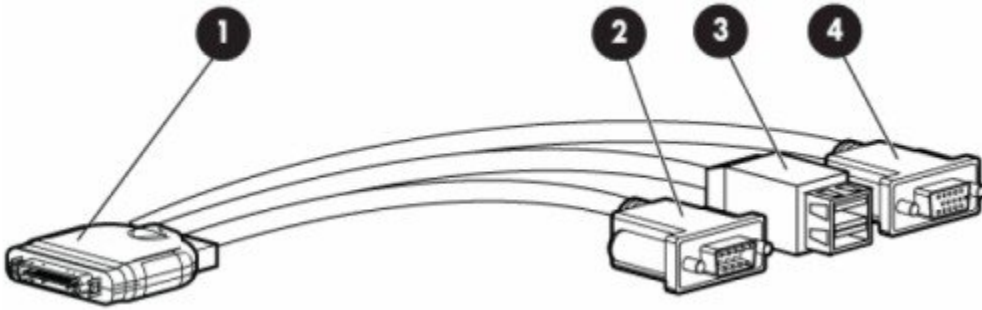

The interfaces for the cable are:

- 1 Front panel KVM/Console connector
- 2 DB9 serial port connector
- 3 Dual Type-A USB 2.0 connectors
- 4 DB15 Video connector

Cisco 8540 WLC Rear Panel View

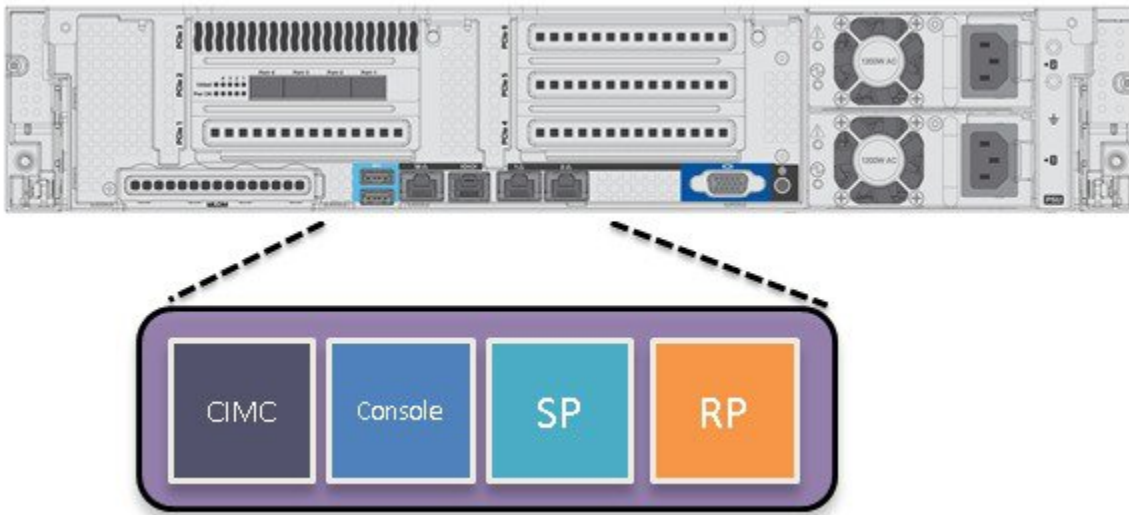

The rear panel has the following interfaces:

- 1 Two Type-A 3.0 USB ports
- 2 IMC port 10/100/1000 Base-T

To setup the CIMC interface:

- Connect the CIMC cable.
- To enable DHCP to set the IP, use the command **imm dhcp enable**.
- If DHCP is not available, use the command **imm address <ip address> <net mask> <gateway ip>**.
- To view the IP and details, use the command **imm summary**.

(Cisco Controller) >imm ?

```
address      IMM Static IP configuration
dhcp         Enable | Disable | Fallback DHCP
restart      Saves settings and Restarts IMM Module
summary      Displays IMM Parameters
username     Configures Login Username for IMM
```

(Cisco Controller) >show imm chassis ?

```
bios         Fetch Chassis BIOS information
current      Fetch Chassis Current information
fan          Fetch Chassis FAN information
mac         Fetch Chassis MAC information
memory       Fetch Chassis Memory information
power-supply Fetch Chassis Power Supply information
sol-info     Fetch Serial Over Lan information
temperature  Fetch Chassis Temperature information
```



Note CIMC web interface is for advanced debugging for TAC and escalation use ONLY. Changing of settings in the CIMC by customer can cause adverse impact on controller software and functionality.

- 3 Serial COM connector — Standard RS-232 Serial COM port using RJ-45 connector
- 4 Ethernet service port (SP) — Management 10/100/1000 Base-T
- 5 Redundancy Port (RP)

LED Indicator Color	Function	
Bi-color Yellow (Amber) Green	Management Interface Port Speed	
	State	Decode
	Off	Link Speed = 10 Mbps
	Amber On	Link Speed = 100 Mbps
	Green On	Link Speed = 1 Gbps

LED Indicator Color	Function	
Bi-color Yellow (Amber) Green	Management Interface Port Status	
	State	Decode
	Off	No Link
	Green On	Link
	Blinking	Traffic Present

- 6 VGA Connector — Rear panel has a standard VGA port using a female D-Sub-15 Connector
- 7 ID Switch and LED
- 8 Four 1/10 G Management and Network ports

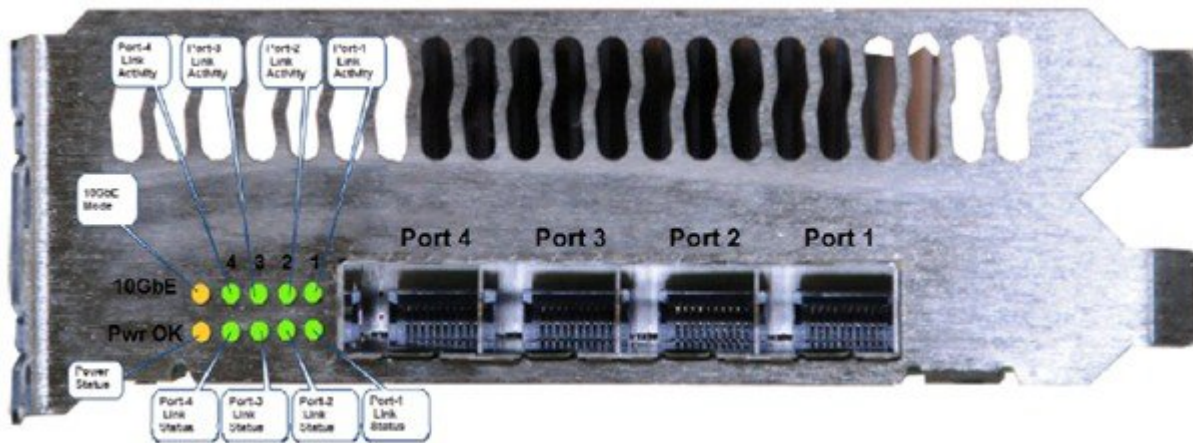

LED	Functional Definition
Pwr OK	LED: (Amber) On indicates power is good
10 G	LED: (Amber) On indicates 10 G mode LED: Off indicates 1 G mode
Port-n Link Status	LED: (Green) On indicates link up status
Port-n Link Activity	LED: (Green) blinking indicates link activity

Switching Between 10 G and 1 G

- If there is nothing installed in port 1, the board will be configured for 10 G mode by default. Therefore, to switch to 1 G mode, an SFP module must be installed in port 1 and the system needs to be rebooted.

- Conversely, if an SFP module is installed and the user wants to switch to 4 x 10 G mode, then an SFP+ module must be installed in port 1 and the WLC rebooted.
- Thus, Online Insertion and Removal (OIR) of SFP and SFP+ between 10 G and 1 G is not possible.
- OIR of 10 G to 10 G and 1 G and 1 G is possible.



Note It is recommended to have all ports as either 10 G or 1 G. In case they are different, port 1 SFP determines the mode of operation and functionality on the other SFPs may not work.

SFP Support

Network ports for 8540 WLC support the following Cisco SFP/SFP+ modules:

- GLC-T
- SFP-10G-SR
- SFP-10G-LR
- SFP-10G-LRM
- SFP-H10GB-CU1M
- SFP-H10GB-CU2M
- SFP-H10GB-CU2-5M
- SFP-H10GB-CU3M
- SFP-H10GB-CU5M
- SFP-H10GB-ACU7M
- SFP-H10GB-ACU10M
- SFP-10G-AOC7M
- SFP-H10GB-CU1-5M
- SFP-10G-AOC3M
- SFP-10G-AOC1M
- SFP-10G-AOC2M
- SFP-10G-AOC5M
- SFP-10G-AOC10M
- GLC-LH*
- GLC-EX-SMD*
- GLC-SX-MMD*



Note

The Cisco 8540 WLC requires GLC-T module on port 1

Image Specifications

Cisco 8540 WLC supports all the features of release 8.1.

Feature Not Supported on 8540 Controller Platform

The following features are not supported on the 8540 Controller platform:

- Local Authentication (where the controller acts as the authentication server)
- Internal DHCP server
- Wired Guest

Fault Tolerance Capability

The Cisco 8540 supports the stateless N+1 redundancy model . The N+1 HA architecture provides redundancy for controllers across geographically separate data centers with low cost of deployment. A single backup controller can be used to provide backup for multiple primary WLCs.

For more information on this model of redundancy, refer to

http://www.cisco.com/c/en/us/td/docs/wireless/technology/hi_avail/N1_High_Availability_Deployment_Guide/N1_HA_Overview.html.

AP and Client SSO

High Availability Stateful Switchover (SSO) model provides a Box-to-Box redundancy with one controller in active state and another controller in hot standby state. The SSO model monitors the health of the active controller via a redundant (HA) port. Cisco 8540 wireless LAN controller has a failover RP Port.

The configuration on the active controller is synched to the standby controller using the redundant port. In HA, both controllers share the same set of configuration including the IP address of the management interface. The AP's CAPWAP state (for APs in RUN state) is also synched. As a result, APs do not go into Discovery state when the active controller fails. Also, a client's information is synched to the standby WLC when the client associates to the WLC or the client's parameters change. Fully authenticated clients, that is, the ones in Run state, are synched to the standby. Thus, client re-association is avoided on switchover, making the failover seamless for the APs as well as for the clients, resulting in zero client service downtime and no SSID outage.

For more information on the SSO feature and the supported topologies, refer to the [High Availability deployment Guide](#).

Active Controller

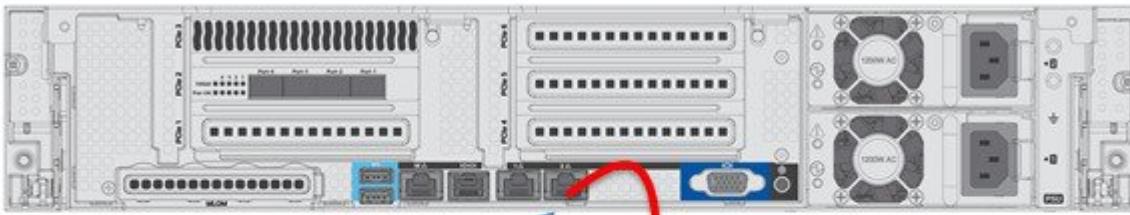

Redundancy Port

Standby Controller

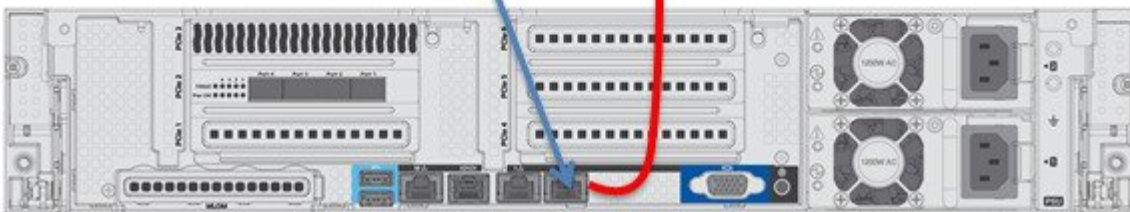

Connecting Cisco 8540 SSO Pair to the Wired Network

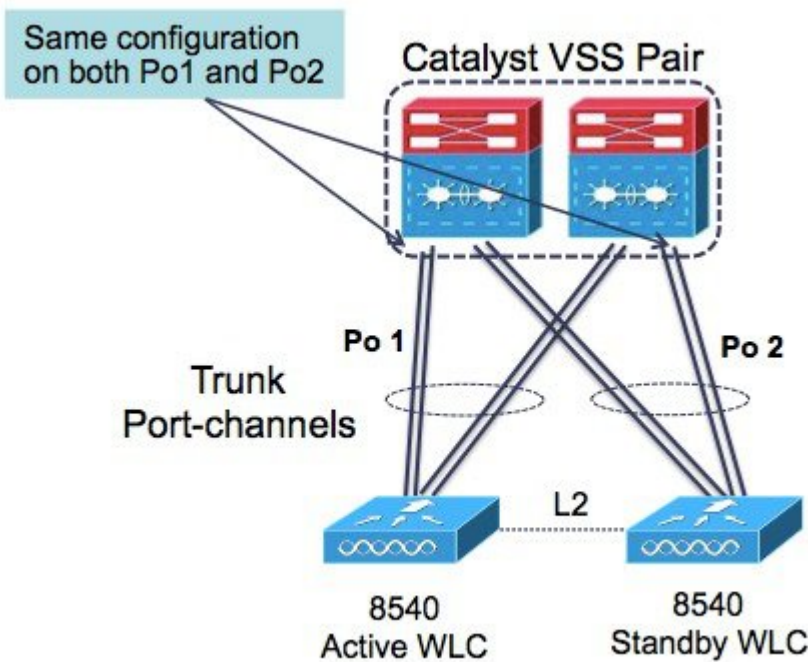

It is recommended to connect to a VSS pair and spread the links in each port-channel between the two physical switches to prevent a WLC switchover upon a failure of one of the VSS switches.

Customer Replaceable Units

Cisco 8540 wireless LAN controller has a minimal amount of separate orderable items, including all of the following:

- Power supply
- SSD Hard Disk Drive (HDD)
- HDD and power supply are hot-swappable on the Cisco 8540 WLC



Note The power supply units are field replaceable.

Link Aggregation (LAG)

A single LAG across the 4 x 10 G interfaces is supported in software versions 8.1 and later. LACP and PAgP are not supported on the controller.

Inter-Platform Mobility and Guest Anchor Support

Guest anchor capability with:

- Cisco WLC 2504/5508 / 8510 / 7510 / WISM2 running as a foreign controller (EOIP Tunnel)
- Cisco 5520 / 8540 WLC running as a foreign controller (EOIP Tunnel)
- Cisco 5760 WLC running as a foreign controller with new mobility turned on (CAPWAP Tunnel)

Foreign controller to a guest anchor which is a:

- Cisco WLC 2504/5508 / 8510 / 7510 / WISM2 (EOIP Tunnel)
- Cisco 5520 / 8540 WLC (EOIP Tunnel)
- Cisco 5760 WLC with new mobility turned on (CAPWAP Tunnel)

CAPWAP has native management plane encryption and optional data payload encryption.

Infrastructure Multicast

Multicast support is enabled in the Cisco 8540 controller with the following restrictions:

- If all APs on the 8540 controller are configured in Local mode, Multicast-Multicast will be the default mode and all features are supported (for example, VideoStream).

If the APs are configured as a mix of Local mode and FlexConnect mode:

- If IPv6 is required on the FlexConnect APs:
 - Disable Global Multicast Mode and change to Multicast-Unicast mode.

- IPv6 / GARP will work on FlexConnect and Local mode APs, but Multicast data and the VideoStream feature will be disabled.
- IPv6 / GARP is not required on FlexConnect APs:
 - Change the mode to Multicast-Multicast and enable Global Multicast Mode and IGMP / MLD snooping.
 - IPv6, GARP, Multicast Data, and VideoStream are supported on local mode APs.

New Mobility and MC Support

Cisco 8540 supports the new mobility functionality to be compatible with inter-platform IRCM and guest anchor support. This platform will not function as an MC.

Look and Feel of the Cisco 8540 Wireless LAN Controller

The Cisco 8540 controller enables console redirect by default with baud rate 9600, simulating a VT100 terminal with no flow control. The 8540 controller has the same boot sequence as existing controller platforms.

Boot Up and Initial Configuration

- Initial Boot Sequence
- Boot Options
- Loading the OS and Boot Loader
- Loading Controller Services

Initial Controller Configuration

Configuration Wizard — As with all other controller platforms, initial boot up requires configuration using the Wizard menu.

WLAN Express Setup — As with all other controller platforms, 8540 WLC also supports the Express WLAN Setup over wired Ethernet connection.

1 Set Up Your Controller

System Name ?

Country ?

Date & Time

Timezone ?

NTP Server ?

Management IP Address ?

Subnet Mask

Default Gateway

Management VLAN ID ?

1 Set Up Your Controller

2 Create Your Wireless Networks

Employee Network

Network Name

Security

Pass Phrase

Confirm Pass Phrase

VLAN

DHCP Server Address

Guest Network

Back Next

 **Guest Network**

Network Name ?

Security ?

VLAN ?

VLAN IP Address

VLAN Subnet Mask

VLAN Default Gateway

VLAN ID ?

DHCP Server Address

3 Advanced Setting

1 Set Up Your Controller

2 Create your Wireless Networks

3 Advanced Setting

RF Parameter Optimization

Client Density Low Typical High

Traffic Type

Virtual IP Address

Local Mobility Group

Service Port Interface

Service Port IP Address

Service Port Netmask

Back Next

Monitoring and Best Practices

This platform supports the Monitoring Dashboard and the Upgrade audit workflow view with release 8.1.

Management Web UI

The management web interface has the same look and feel as existing Cisco wireless LAN controllers.

Save Configuration | Eng | Logout | Settings

MONITOR | WLANs | CONTROLLER | WIRELESS | SECURITY | MANAGEMENT | COMMANDS | HELP | FEEDBACK

Monitor

- Summary
- Access Points
- Cisco CleanAir
- Statistics
- CDP
- Rogues
- Clients
- Sleeping Clients
- Multicast
- Applications
- Lyc
- Local Profiling

Summary

6000 Access Points Supported



Controller Summary

Management IP Address	9.6.93.2, 11/128
Service Port IP Address	10.104.173.120, 11/128
Software Version	8.1.10.178
Emergency Image Version	8.0.77.6
System Name	Khanda-Bardeen
Up Time	0 days, 0 hours, 1 minutes
System Time	Thu Feb 26 04:36:42 2015
Redundancy Mode	Disabled
Internal Temperature	+26 C
802.11a Network State	Enabled
802.11b/g Network State	Enabled
Local Mobility Group	NiagaraGrp
CPU(s) Usage	0%
Individual CPU Usage	0%/1%, 0%/1%, 0%/0%, 0%/0%, 0%/0%, 0%/0%, 0%/0%, 0%/0%, 0%/0%
Memory Usage	28%

Access Point Summary

	Total	Up	Down	
802.11a/n/ac Radios	0	0	0	Detail
802.11b/g/n Radios	0	0	0	Detail
Dual-Band Radios	0	0	0	Detail
All APs	0	0	0	Detail

Rogue Summary

Active Rogue APs	0	Detail
Active Rogue Clients	0	Detail
Adhoc Rogues	0	Detail
Rogues on Wired Network	0	

Top WLANs

Profile Name: _____ # of Clients: _____

Most Recent Traps

Link Up: Slot: 0 Port: 4 Admin Status: Enable Oper Status: Link Up retry-1

Link Up: Slot: 0 Port: 3 Admin Status: Enable Oper Status: Link Up retry-1

Link Up: Slot: 0 Port: 1 Admin Status: Enable Oper Status: Link Up retry-1

Interface: management IPv6 address status =REACHABLE, IPv6 Address =fe80::f60f:1bff:fe1e:72f

Cold Start:

[View All](#)

Top Applications

Application Name	Packet Count	Byte Count
View All		

This page refreshes every 30 seconds.

The screenshot displays the Cisco Prime Infrastructure interface for a Controller. The left sidebar lists various configuration categories, and the main area shows the 'Inventory' page. A table lists the following information:

Model No.	AIR-CT8540-K9
Burned-in MAC Address	F4:4E:05:9F:00:6D
Maximum number of APs supported	6000
FIPS Prerequisite Mode	Disable
WLANCC Prerequisite Mode	Disable
UCAPL Prerequisite Mode	Disable
UDI :	
Product Identifier Description	AIR-CT8540-K9
Version Identifier Description	V01
Serial Number	FCH1839V2BY
Entity Name	Chassis
Entity Description	Cisco 8540 Wireless LAN Controller

Licensing

8540 Wireless LAN Controller supports Right to Use (RTU) licensing model similar to the Cisco Flex 7500 and Cisco 8500 series controllers. This is an Honor-based licensing scheme that allows AP licenses to be enabled on supported controllers with End User License Agreement (EULA) acceptance. The RTU license scheme simplifies addition, deletion, or the transfer of AP adder licenses in the field by eliminating the need for an additional step, additional tools, or access to Cisco.com for PAK license or return materials authorization (RMA) transfers.

Evaluation licenses are valid for 90 days. Notifications will be generated to inform you to buy a permanent license starting 15 days prior to the evaluation license expiration.

If you have more APs connected than those purchased, the licensing status for the controller tracked within the Cisco Prime Infrastructure will turn red.

For more information on the RTU License model, refer to the [Cisco Right to Use Licensing \(RTU\)](#) document.

License Types

These are the three license types:

- **Permanent licenses**—The AP count is programmed into NVM while manufacturing; this is also referred to as Base AP count licenses. These licenses are transferable.
- **Adder access point count licenses**—Can be activated through the acceptance of the EULA. These licenses are transferable.

- **Evaluation licenses**—Used for demo and/or trial periods, are valid for 90 days, and default to the full capacity of the controller. The evaluation license can be activated at any time using a CLI command.

Licensing Model Features

- Two Base Bundle SKUs: AIR-CT8540-K9 and AIR-CT8540-1K-K9
- Portability of licenses between 5520 and 8540 wireless LAN controllers
- No separate HA-SKU UDI

Table 9: 8540 – Primary SKUs / PIDs

SKU / PID	Description	Comments
AIR-CT8540-K9	Cisco 8540 wireless controller w/rack mounting kit	Base and HA SKU
AIR-CT8540-1K-K9	Cisco 8540 wireless controller supporting 1000 APs w/rack kit	1000 AP Bundle SKU
LIC-CT8540-UPG	Top level SKU for 8540 AP adder licenses	—
LIC-CT8540-1A	Cisco 8540 wireless controller 1 AP adder license	—



Americas Headquarters
Cisco Systems, Inc.
San Jose, CA 95134-1706
USA

Asia Pacific Headquarters
Cisco Systems (USA) Pte. Ltd.
Singapore

Europe Headquarters
Cisco Systems International BV
Amsterdam, The Netherlands

Cisco has more than 200 offices worldwide. Addresses, phone numbers, and fax numbers are listed on the Cisco Website at www.cisco.com/go/offices.